

PROFESSIONAL WIFI WEATHER STATION

Operation Manual

Model: HP2551

Thank you for purchasing this Professional WIFI Weather Station! This device provides accurate weather readings and is Wi-Fi capable to stream data from the weather station to Internet based weather services.

This manual will guide you, step-by-step, through setting up your weather station and console, and understanding the operation of your weather station. Use this manual to become familiar with your professional weather station and save it for future reference.





- * Please scan the QR code to read English manual and keep it for future reference
- * Bitte scannen Sie den QR-Code zudeutsche Anleitung lesen und aufbewahren füZukunftsbezug
- * Si prega di scansionare il codice QR perleggi il manuale italiano e conservalo perReferenza futura

Instruction manuals

<https://www.ecowitt.com/support/download/1>

Help

Our product is continuously changing and improving, particularly online services and associated applications. To download the latest manual and additional help, please contact our technical support team:

support@ecowitt.com

support.eu@ecowitt.net (EU/UK)



MADE IN CHINA



AC WORKS CONSULTING Srl
Via Vilfredo Pareto 125,47521
Casena(FC),ITALY

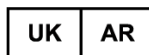

HUA TENG LIMITED
3 Glass Street, Hanley, Stoke On Trent,
ST1 2ET United Kingdom

Table of Contents

1 WARNINGS AND CAUTIONS	5
2 UNPACKING	5
3 OVERVIEW	7
3.1 DISPLAY CONSOLE	7
3.2 INDOOR SENSOR	8
3.3 FEATURES	9
4 SET UP GUIDE	11
4.1 PRE INSTALLATION CHECKOUT	11
4.2 SITE SURVEY	12
4.3 SENSOR PACKAGE ASSEMBLY	13
4.3.1 Install U-bolts and metal plate	13
4.3.2 Install wind vane	14
4.3.3 Install wind speed cups	15
4.3.4 Install Batteries in sensor package	15
4.3.5 Mount assembled outdoor sensor package	16
4.3.6 Reset Button and Transmitter LED	18
4.4 INDOOR SENSOR SET UP	19
4.5 MULTI-CHANNEL TEMPERATURE AND HUMIDITY SENSOR (OPTIONAL)	20
4.5.1 Install batteries	20
4.5.2 Sensor Placement	22
4.6 BEST PRACTICES FOR WIRELESS COMMUNICATION	23
4.7 CONSOLE DISPLAY	24
4.7.1 Initial Display Console Set Up	26
4.7.2 Key functions	27
4.7.3 Main interface icons explain	29
4.8 MULTIPLE CHANNEL SELECTION AND SCROLL MODE	31
4.9 HISTORY MODE	32
4.9.1 View and Reset MAX/MIN	32
4.9.2 History Record Mode	33
4.9.3 Graph Mode	36
4.9.4 Optional Sensor Display Mode	37
4.10 SETTING MODE	37
4.10.1 Date and Time setting	39
4.10.2 Time Format setting	40
4.10.3 Date Format setting	41
4.10.4 Temperature unit setting	41

4.10.5 Barometric unit	41
4.10.6 Wind speed unit	41
4.10.7 Rainfall unit	41
4.10.8 Solar Rad. Unit	41
4.10.9 Multi Channel Sensor	41
4.10.10 Backlight setting	43
4.10.11 Longitude: Latitude setting	45
4.10.12 Barometric display	45
4.10.13 Rainfall season (default: January)	45
4.10.14 Storing Interval (1-240minutes Selectable)	46
4.10.15 Weather Server	46
4.10.16 Connect Console to Your Router: Wi-Fi scan	63
4.10.17 Background	65
4.11 ALARM SETTING MODE	65
4.12 CALIBRATION MODE	67
4.13 MORE	72
4.14 FACTORY RESET	76
4.14.1 Re-register indoor transmitter	76
4.14.2 Re-register outdoor transmitter	76
4.14.3 Automatic Clear Max/Min	77
4.14.4 Reset to Factory	77
4.14.5 Clear History	77
4.14.6 Clear Max/Min	77
4.14.7 Backup data	78
4.14.8 About information	78
5 OTHER CONSOLE FUNCTIONS	79
5.1 BEAUFORT WIND FORCE SCALE	79
5.2 WEATHER FORECASTING	79
5.3 LIGHTNING ALERT	80
5.4 WEATHER FORECASTING DESCRIPTION AND LIMITATIONS	81
5.5 MOON PHASE	81
6 MAINTENANCE	83
7 TROUBLESHOOTING GUIDE	84
8 SPECIFICATIONS	87
9 WARRANTY INFORMATION	89

1 Warnings and Cautions

Warning:

- Any metal object may attract a lightning strike, including your weather station mounting pole. Never install the weather station in a storm.
- If you are mounting the weather station to a house or structure, consult a licensed electrician for proper grounding. A direct lightning strike to a metal pole can damage or destroy your home.
- Installing your weather station in a high location may result in injury or death. Perform as much of the initial check out and operation on the ground and inside a building or home. Only install the weather station on a clear, dry, day.

2 Unpacking

Open your weather station box and inspect that the contents are intact (nothing broken) and complete (nothing missing). Inside you should find the following:

QT	Item Description
1	Display Console
1	Outdoor Sensor Body with built-in: Thermo-hygrometer / Rain Gauge / Wind Speed Sensor/ Wind Direction Sensor, Light and UV sensor, Solar panel
1	Wind speed cups (to be attached to outdoor sensor body)
1	Wind vane (to be attached to outdoor sensor body)
1	Indoor sensor unit(temp/humidity/pressure)
2	U-Bolts for mounting on a pole
4	Threaded nuts for U-Bolts (M6 size)
1	Metal mounting plate to be used with U-Bolts
1	Wrench for M6 bolts
1	AC adapter
1	User manual (this manual)

Table: Package content

If components are missing from the package, or broken, please contact customer service to resolve the issue.

Note: Batteries for the outdoor sensor package are **not included**. You will need 2 AA size batteries, alkaline or Lithium batteries (Lithium recommended for colder climates).

Note: The console operates using an AC adapter. The included adapter is a switching-type adapter and can generate a small amount of electrical interference with the RF reception in the console, when placed too close to the console. Please keep the console display at least 2 ft. or 0.5 m away from the power adapter to ensure best RF reception from the outdoor sensor package.

Note: The console can store historical data on a memory card. This memory card is **not included**. If you want to use one you will need a microSD memory card. The supported max capacity of the card is 32G (Format: FAT32). A 1GB card will store more than 10 years' worth of data, so you do not need a very large capacity card. There is also no requirement on the speed class of this card as data writing happens infrequently and is not speed critical.

3 Overview

3.1 Display console

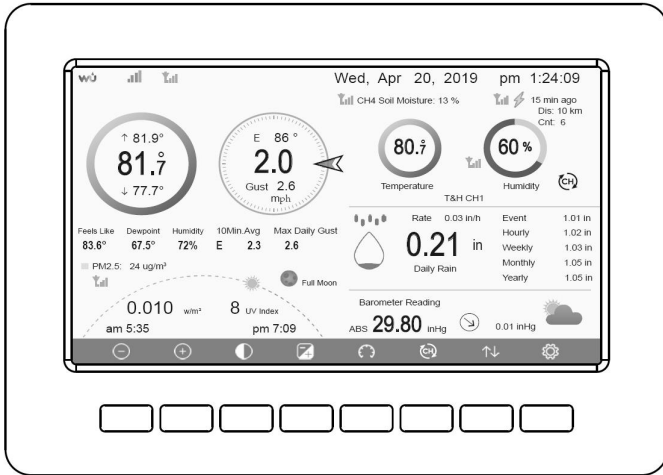

Figure 1: Display console screen

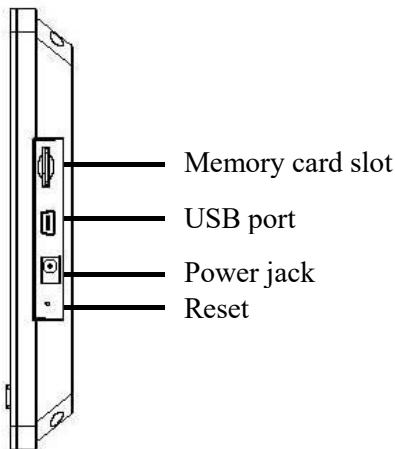

Figure 2: Display console side views

Note: The USB port in the console of weather station is only for firmware update, not for data communication (USB cable not included).

You can use a micro SD card (max 32G, Fat 32) for the firmware update.(SD card not included).

Update firmware process:

- 1.Visit www.ecowitt.com for available update
- 2.On the navigation bar, select Manual & Firmware under Support
- 3.Search "HP2551" - find the firmware option and download it on your computer
- 4.Take out your micro SD card from the console
- 5.Drag the unzipped file(user.bin) under the root directory of your micro SD card.
6. Insert the card into the console, then it will update the firmware automatically.

3.2 Indoor sensor

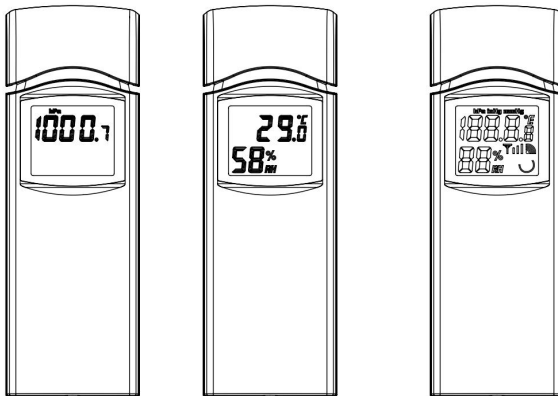

Figure 3: Indoor sensor 2 display variations

The indoor sensor will display indoor temperature, humidity and barometric pressure alternately.

3.3 Features

- 7" large TFT (high resolution) colored display console
- Two background (dark/light) themes selectable
- Indoor temperature, humidity
- Absolute and Relative barometric pressure
- Wind speed, wind direction, rainfall, outdoor temperature and humidity, solar radiation and UV.
- Calculates dew point, wind chill, heat index, moon phase and sunset/sunrise time
- Weather forecast & alarm
- View historical records of sensors and graph directly on the console
- Collects sensor data from various supported wireless sensors.
 - Additional/optional sensors:
 - Up to 8 WH31 multi-channel temperature and humidity sensors
Or 8 WN30 multi-channel temp sensors
 - Up to 8 WN34 Temperature Sensors
 - Up to 4 WH41/WH43 PM2.5 air quality sensors
 - One WH45 PM2.5/PM10/CO2/temperature and humidity all-in-1 sensor
 - Up to 8 WH51 soil moisture sensors
 - Up to 4 WH55 water leak sensors
 - One WH57 lightning sensor
 - Future sensors to be developed
- Pushes sensor data to cloud weather services:
 - <https://www.ecowitt.net>
 - <https://www.wunderground.com>
 - <https://www.weathercloud.com/>
 - <https://www.wow.com>

- Custom own server data hosting possible when server data exchange is compatible with either Wunderground or Ecowitt protocol.
- Manage sensor calibration setup.
- Manage sensor via sensor ID.
- Data storage service on Ecowitt server: <https://ecowitt.net>
 - Data storing interval:
 - by day: 5 minutes
 - by week: 30 minutes
 - by month: 4 hours
 - by year: 1 day
- Stores data for past three months at 5-minute intervals
- Stores data for past one year at 30-minute intervals
- Stores data for past two year at 4-hour intervals

Note: The optional sensors can be purchased separately. If more info needed, please visit our website: <http://www.ecowitt.com>. Make sure to select the model of the units with the same RF frequency as your gateway (the frequency is different for various countries because of regulations).

Note: To pair the optional sensors with the HP2551 console, please follow the below operations:

1. Place the optional sensor next to the console(keep 5-10ft away from each other).
2. Install batteries on the sensor and wait for 1-2 minutes.
3. Check whether the console will pick up the sensor data automatically and display it on the screen.
4. If not, press the gear icon and go to Setup page - find More and enter its Setup page - find Sensors ID and enter its Setup page.

5. In the Sensors ID Setup page, find the sensor you want to pair - select the ID number box and register it.
6. Once successfully, you may return to the main interface to check the data.
7. If you know exactly the sensor ID, and want console to pair that sensor only, you may enter the sensor ID, and save the change to make it effect.

4 Set up Guide

4.1 Pre Installation Checkout

To complete assembly you will need a Philips screwdriver (size PH0) and a wrench (size M6; included in package).

Note: We suggest you assemble all components of the weather station, including console in one location so you can easily test functionality. After testing, place the outdoor sensor package in the desired location. Note, however, that movement during assembly, and movement after assembly can cause the rain sensor to “falsely” register rain. It is therefore best if you do not connect the console to any Internet services until you have reset these false readings using the console. The errant values may be hard to remove from Internet services if you do not reset first.

Attention:

- Follow suggested order for battery installation (outdoor sensor first, console second)
- Ensure batteries are installed with correct polarity (+/-)
- Do not mix old and new batteries
- Do not use rechargeable batteries
- If outdoor temperature may go below 32F or 0C for prolonged periods, Lithium based batteries are suggested over alkaline type batteries for the outdoor sensor array

4.2 Site Survey

Perform a site survey before installing the weather station. Consider the following:

1. You must clean the rain gauge every few months and change the batteries every 2-3 years. Provide easy access to the weather station.
2. Avoid radiant heat transfer from buildings and structures. In general, install the sensor array at least 5' or 1.52m from any building, structure, ground, or roof top.
3. Avoid wind and rain obstructions. The rule of thumb is to install the sensor array at least four times the distance of the height of the tallest obstruction. For example, if the building is 20' or 6.10m tall and the mounting pole is 6' or 1.83m tall, install the sensor array $4 \times (20 - 6)' = 56'$ or $4 \times (6.1 - 1.83) = 17.08\text{m}$ away.
4. Mount the sensor array in direct sunlight for accurate temperature readings.
5. Installing the weather station over sprinkler systems or other unnatural vegetation may affect temperature and humidity readings. We suggest mounting the sensor array over natural vegetation.
6. Wireless Range. Radio communication between receiver and transmitter in an open field can reach a distance of up to 330 feet or 100 meter, providing there are no interfering obstacles such as buildings, trees, vehicles and high voltage lines. Wireless signals will not penetrate metal buildings. Under most conditions, the maximum wireless range is 100' or 30m.
7. Radio Interference. Computers, radios, televisions and other sources can interfere with radio communications between the sensor array and console. Please take this into consideration when choosing console or mounting locations. Make sure your display console is at least five feet or 1.52 meter away from any electronic device to avoid interference.

4.3 Sensor Package Assembly

See Figure 5 to locate and understand all the parts of the outdoor sensor package once fully assembled.

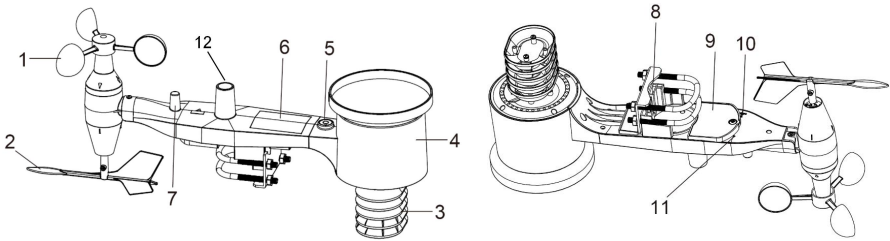

Figure 5: Sensor assembly components

1. Wind Speed cups	7. Antenna
2. Wind Vane	8. U-Bolts
3. Thermo- and hygro-meter sensors	9. Battery compartment door
4. Rain collector	10. Reset button
5. Bubble level	11. LED (red) to indicate data transmission
6. Solar panel	12. Light sensor and UV sensor

Table: Sensor assembly detailed items

4.3.1 Install U-bolts and metal plate

Installation of the U-bolts, which are in turn used to mount the sensor package on a pole, requires installation of an included metal plate to receive the U-bolt ends. The metal plate, visible in Figure 6 on the right side, has four holes through which the ends of the two U-Bolts will fit. The plate itself is inserted in a groove on the bottom of the unit (opposite side of solar panel). Note that one side of the plate has a straight edge (which goes into the groove), the other side is bent at a 90-degree angle and has a curved profile (which will end up “hugging” the mounting pole). Once the metal plate is inserted, remove nuts from the U-Bolts and insert both U-bolts through the respective holes of the metal plate as shown in Figure 6 .

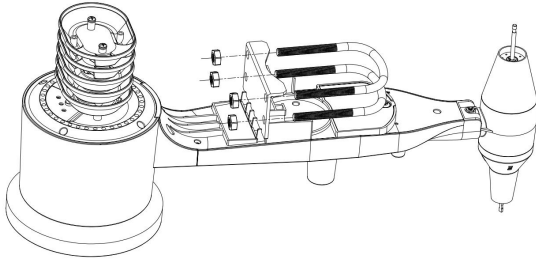

Figure 6: U-Bolt installation

Loosely screw on the nuts on the ends of the U-bolts. You will tighten these later during final mounting. Final assembly is shown in Figure 7 .

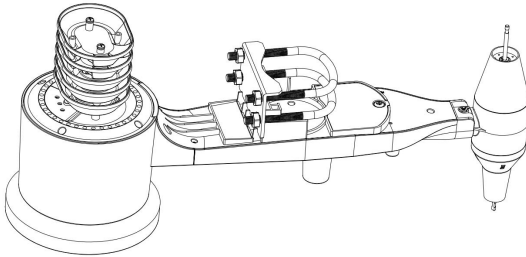

Figure 7: U-Bolts and nuts installed

The plate and U-Bolts are not yet needed at this stage but doing this now may help avoid damaging wind vane and wind speed cups later on. Handling of the sensor package with wind vane and speed cups installed to install these bolts is more difficult and more likely to lead to damage.

4.3.2 Install wind vane

Push the wind vane onto the shaft on the bottom side of the sensor package, until it goes no further, as shown on the left side in Figure 8 . Next, tighten the set screw, with a Philips screwdriver (size PH0), as shown on the right side, until the wind vane cannot be removed from the axle. Make sure the wind vane can rotate freely. The wind vane's movement has a small amount of friction, which is helpful in providing steady wind direction measurements.

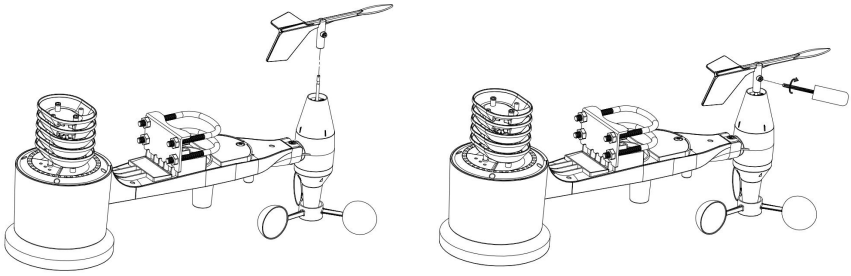

Figure 8: Wind vane installation diagram

4.3.3 Install wind speed cups

Push the wind speed cup assembly onto the shaft on the opposite side of the wind vane, as shown in Figure 9 on the left side. Tighten the set screw, with a Philips screwdriver (size PH0), as shown on the right side. Make sure the cup assembly can rotate freely. There should be no noticeable friction when it is turning.

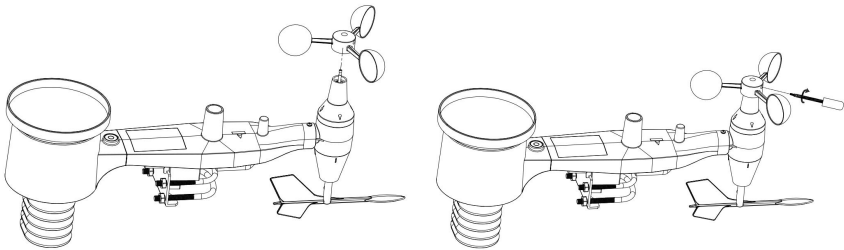

Figure 9: Wind speed cup installation diagram

4.3.4 Install Batteries in sensor package

Open the battery compartment with a screwdriver and insert 2 AA batteries in the battery compartment. The LED indicator on the back of the sensor package (item 9) will turn on for four seconds and then flash once every 16 seconds indicating sensor data transmission. If you did not pay attention, you may have missed the initial indication. You can always remove the batteries and start over, but if you see the flash once every 16 seconds, everything should be OK.

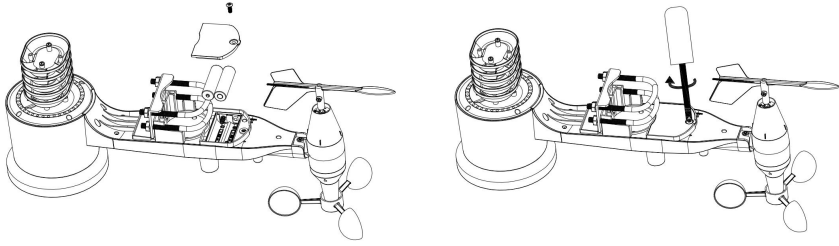

Figure 10: Battery installation diagram

Note: If LED does not light up or is on permanently, make sure the battery is inserted the correct way and inserted fully, starting over if necessary. Do not install the batteries backwards as it may permanently damage the outdoor sensor.

Note: We recommend Lithium batteries for cold weather climates, but alkaline batteries are sufficient for most climates. Rechargeable batteries have lower voltages and should never be used.

4.3.5 Mount assembled outdoor sensor package

4.3.5.1 Before you mount

Before proceeding with the outdoor mounting detailed in this section, you may want to skip to setup instructions in section 5.7 and onwards first, while you keep the assembled outdoor sensor package nearby (although preferably not closer than 5 ft. from the console). This will make any troubleshooting and adjustments easier and avoids any distance or interference related issues from the setup.

After setup is complete and everything is working, return here for outdoor mounting. If issues show up after outdoor mounting they are almost certainly related to distance, obstacles etc.

4.3.5.2 Mounting

You can attach a pipe to a permanent structure and then attach the sensor package to it (see Figure 11). The U-Bolts will accommodate a pipe diameter of 1-2 inches (pipe not included).

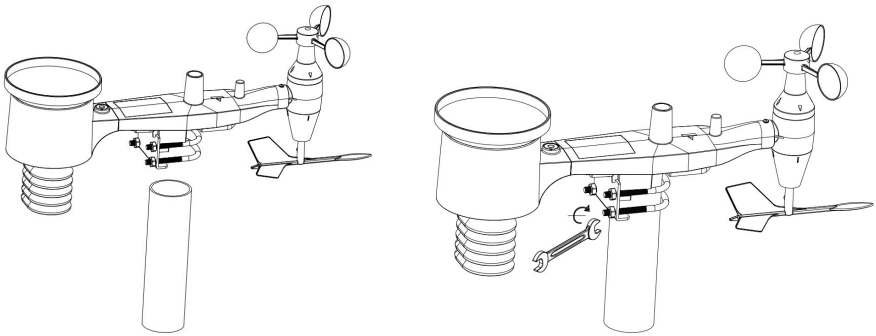

Figure 11: Sensor package mounting diagram

Make sure the mounting pipe is vertical, or very close to it. Use a level if needed.

Finally, place the sensor package on top of the prepared mounting pipe. The U-Bolts should be loose enough to allow this but loosen the nuts as necessary. Once placed, hand tightens all four nuts, taking care to do so evenly. Do not use a wrench yet!

Now you will need to align the whole package in the proper direction by rotating it on top of the mounting pipe as needed. Locate the arrow labeled “WEST” that you will find on top of the sensor package right next to the light sensor, on the opposite side of the solar panel. You must rotate the whole sensor package until this arrow points due west. To achieve proper alignment, it is helpful to use a compass (many cell phones have a compass application). Once rotated in the correct orientation, lightly tighten the bolts a little more (use a wrench) to prevent further rotation.

Note: The orientation to WEST is necessary for two reasons. The most important one is to position the solar panel and light sensor in the most advantageous position for recording solar radiation and charging internal capacitors. Secondly it causes a zero reading for wind direction to correspond to due NORTH, as is customary. This orientation is correct for installations in the northern hemisphere. If you are installing in the southern hemisphere, the correct orientation to achieve the same optimal positioning is to have the “WEST”

arrow actually point due EAST! This has the side effect, however, of lining up the 0 reading of the wind direction with SOUTH. This needs to be corrected using a 180-degree offset in the calibration settings (see section 5.12 Calibration Mode).

Now look at the bubble level. The bubble should be fully inside the red circle. If it is not, wind direction, speed, and rain readings may not operate correctly or accurately. Adjust the mounting pipe as necessary. If the bubble is close, but not quite inside the circle, and you cannot adjust the mounting pipe, you may have to experiment with small wooden or heavy cardboard shims between the sensor package and the top of the mounting pole to achieve the desired result (this will require loosening the bolts and some experimentation).

Make sure you check, and correct if necessary, the westerly orientation as the final installation step, and now tighten the bolts with a wrench. Do not over tighten, but make sure strong wind and/or rain cannot move the sensor package.

Note: If you tested the full assembly indoors and then came back here for instructions and mounted to sensor package outdoor you may want to make some further adjustments on the console. The transportation from indoor to outdoor and handling of the sensor is likely to have “tripped” the rainfall sensing bucket one or more times and consequently the console may have registered rainfall that did not really exist. You can use console functions to clear this from history. Doing so is also important to avoid false registration of these readings with weather services.

4.3.6 Reset Button and Transmitter LED

In the event the sensor array is not transmitting, reset the sensor array.

Using a bent-open paperclip, press and hold the **RESET BUTTON** (see Figure 12) to affect a reset: the LED turns on while the RESET button is depressed, and you can now let go. The LED should then resume as normal, flashing approximately once every 16 seconds.

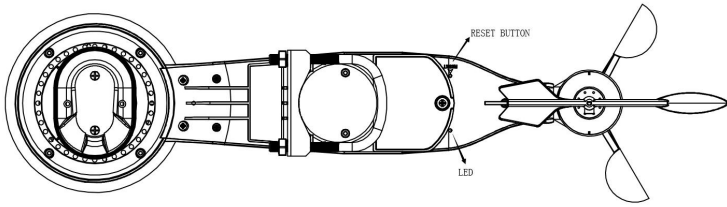

Figure 12: Reset button and Transmitter LED location

4.4 Indoor Sensor Set Up

Note: To avoid permanent damage, please take note of the battery polarity before inserting the batteries. Looking at Figure 13 from left to right the left-most (or bottom) battery is to be installed with its + terminal pointing down, and the other battery with its + terminal pointing up.

Remove the battery door on the back of the sensor by sliding it in the direction of the arrow. Insert two AA batteries as described and put compartment door back and slide it in the opposite direction to lock.

Switch to select temperature display in Celsius or Fahrenheit.

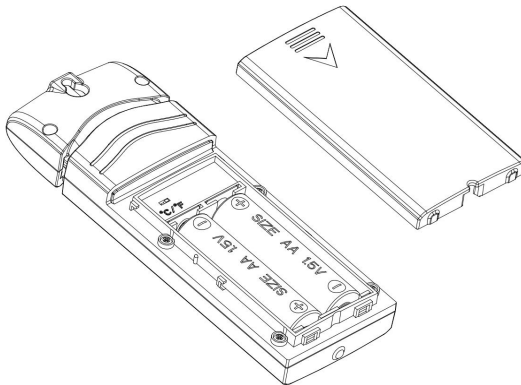

Figure 13: Indoor sensor battery installation

4.5 Multi-channel temperature and humidity sensor (Optional)

4.5.1 Install batteries

1. Remove the battery door on the back of the transmitter(s) by sliding down the battery door, as shown in Figure 14 .

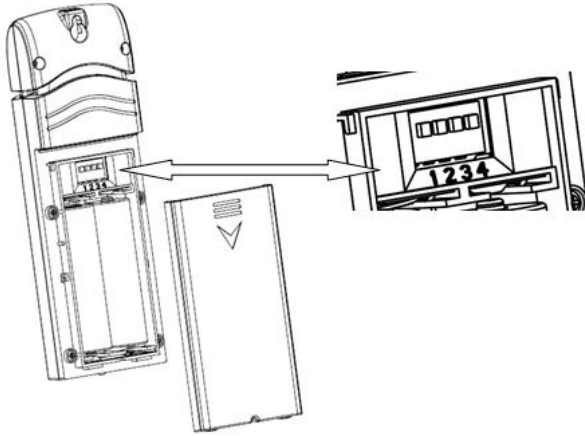

Figure 14: Battery installation for Multi-channel sensor

2. **BEFORE** inserting the batteries, locate the dip switches on the inside cover of the lid of the transmitter.
3. **Channel Number:** The device supports up to eight sensors. To set each channel number, change Dip Switches 1, 2 and 3, as referenced in Figure 15 .
4. **Temperature Units of Measure:** To change the transmitter display units of measure ($^{\circ}\text{F}$ vs. $^{\circ}\text{C}$), change Dip Switch 4, as referenced in Figure 15 .
- 5.
6. Switch in down position. Switch in up position.

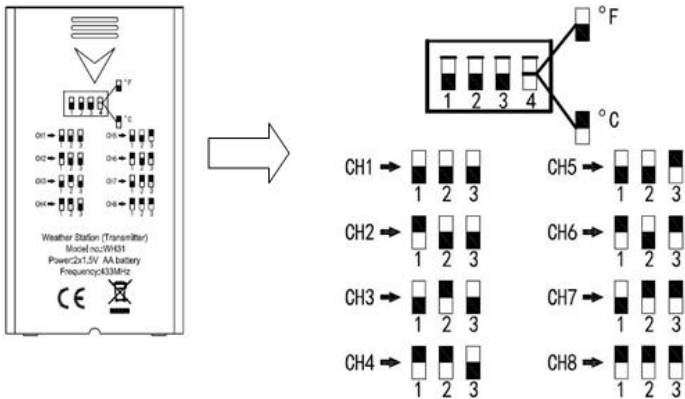

Figure 15: Dip Switch diagram

7. Insert two AA batteries.
8. Verify the correct channel number (CH) and temperature units of measure ($^{\circ}\text{F}$ vs. $^{\circ}\text{C}$) are on the display, as shown in Figure 16 .

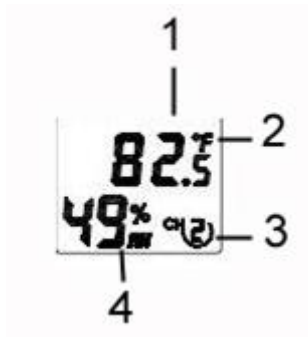

Figure 16: sensor LCD display

- (1) temperature
- (2) temperature units ($^{\circ}\text{F}$ vs. $^{\circ}\text{C}$)
- (3) channel number
- (4) relative humidity

9. Close the battery door.

Repeat for the additional remote transmitters, verifying each remote is on a different channel.

4.5.2 Sensor Placement

The best mounting location for the indoor sensor is in a location that never receives direct sunlight, not even through windows. Also, do not install in a location where a nearby radiant heat source (radiator, heaters, etc.) will affect it. Direct sunlight and radiant heat sources will result in inaccurate temperature readings.

The sensor is meant to provide indoor conditions for display on the console, but if you would rather have a second source for outdoor conditions instead, you can mount this unit outside. The unit is weatherproof, but besides heeding the placement instructions above, you should also attempt to mount the unit under cover (eave or awning or similar).

To mount or hang the unit on a wall or wood beam:

- Use a screw or nail to affix the remote sensor to the wall, as shown on the left side of Figure 17, or
- Hang the remote sensor using a string, as shown in right side of Figure 17

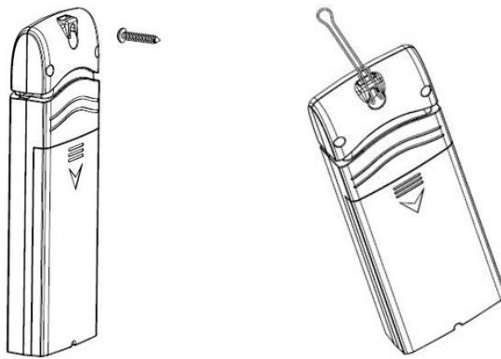

Figure 17: Indoor sensor mounting

Note: Make sure the sensor is mounted vertically and not lying down on a flat surface. This will insure optimum reception. Wireless signals are impacted by distance, interference (other weather stations, wireless phones, wireless routers, TVs and computer monitors), and

transmission barriers, such as walls. In general, wireless signals will not penetrate solid metal and earth (down a hill, for example).

4.6 Best Practices for Wireless Communication

Wireless (RF) communication is susceptible to interference, distance, walls and metal barriers. We recommend the following best practices for trouble free wireless communication between both sensor packages and the console:

- **Indoor sensor placement:** The sensor will have the longest reach for its signal when mounted or hung vertically. Avoid laying it down on a flat surface.
- **Electro-Magnetic Interference (EMI).** Keep the console several feet away from computer monitors and TVs.
- **Radio Frequency Interference (RFI).** If you have other devices operating on the same frequency band as your indoor and/or outdoor sensors and experience intermittent communication between sensor package and console, try turning off these other devices for troubleshooting purposes. You may need to relocate the transmitters or receivers to avoid the interference and establish reliable communication. The frequencies used by the sensors are one of (depending on your location): 433, 868, or 915 MHz (915 MHz for United States, 868 MHz for European, 433 MHz for other area).
- **Line of Sight Rating.** This device is rated at 300 feet line of sight (under ideal circumstances; no interference, barriers or walls), but in most real-world scenarios, including a wall or two, you will be able to go about 100 feet.
- **Metal Barriers.** Radio frequency will not pass through metal barriers such as aluminum siding or metal wall framing. If you have such metal barriers and experience communication problems, you must change the placement of sensor package and or console.

The following table shows different transmission media and expected signal strength reductions. Each “wall” or obstruction decreases the transmission range by the factor shown below.

Medium	RF Signal Strength Reduction
Glass (untreated)	5-15%
Plastics	10-15%
Wood	10-40%
Brick	10-40%
Concrete	40-80%
Metal	90-100%

Table: RF Signal Strength reduction

4.7 Console Display

See Figure 18 to help you identify elements of the console's display screen.

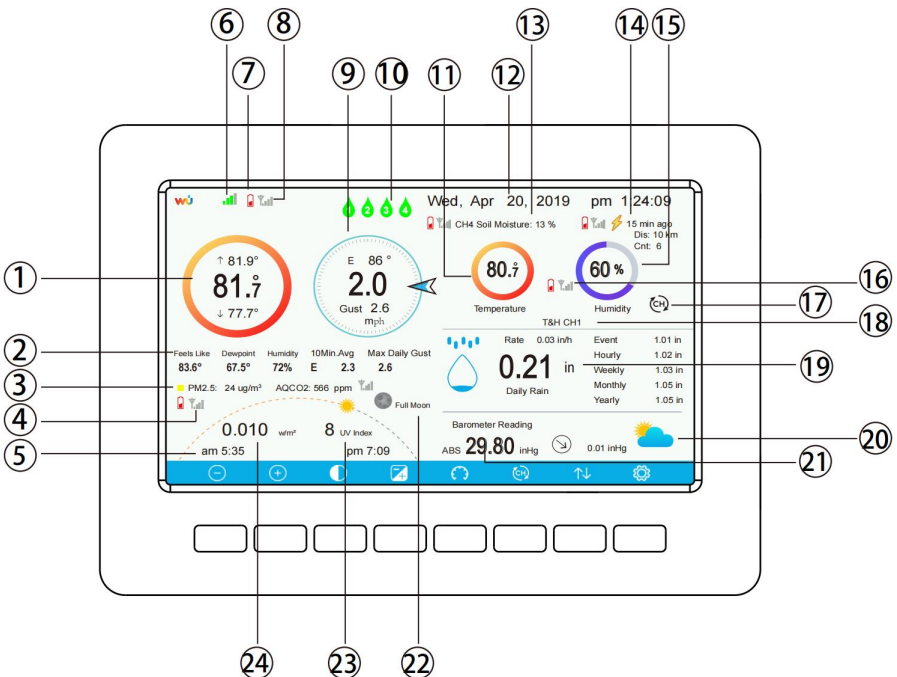

Figure 18: Display Console Screen Layout

No	Description	No	Description
1	Outdoor temperature	13	Soil moisture(optional sensor)
2	Outdoor Feels Like/Dew point/Humidity/10Min. Average Wind Direction/Max Daily Gust	14	Last lightning strikes detected time / distance; daily counts (optional sensor)
3	WH41/WH43/WH45 particle detection sensor cycle display(optional sensor)	15	Indoor humidity
4	RF signal bar for PM2.5 sensor(optional sensor)	16	RF signal bar for multi-channel temperature and humidity sensor(optional sensor)
5	Sunrise / Sunset Time	17	Multi-channel temperature and humidity sensor cycle display mode icon(optional sensor)
6	Wi-Fi signal bar	18	Multi-channel temperature and humidity sensor channel number (optional sensor)
7	Low battery power indicator for each sensor	19	Rain fall Daily/Event/Hourly/Weekly/ Monthly/Yearly
8	RF signal bar for outdoor sensor array	20	Weather forecast
9	Wind direction/Wind speed/Gust	21	ABS/REL Barometer
10	Multi-Channel water leak sensor (optional Sensor)	22	Moon Phase
11	Indoor temperature	23	UV
12	Date and time	24	Solar Radiation

Table: Display console detailed items

Note: If you have purchased the optional WH55 water leak sensor, please check the following instructions for the display color:

- Green - normal
- Red & Flash - leaking
- Yellow - low battery alert
- Orange - offline over 10 mins

If you have purchased the optional WH34 Temperature Sensor, please check and view it on Optional Sensor Display Mode. Because WH34 Temperature Sensor won't display on the main screen of the console.

4.7.1 Initial Display Console Set Up

Immediately after power up (inserting power adapter), the unit will turn on the display, and the unit will start to look for reception of the indoor and outdoor sensor data. This may take up to 3 minutes.

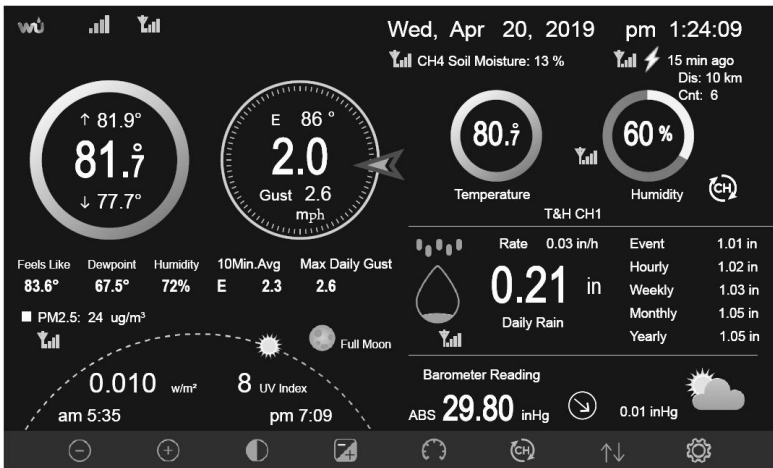

Dark Background Display

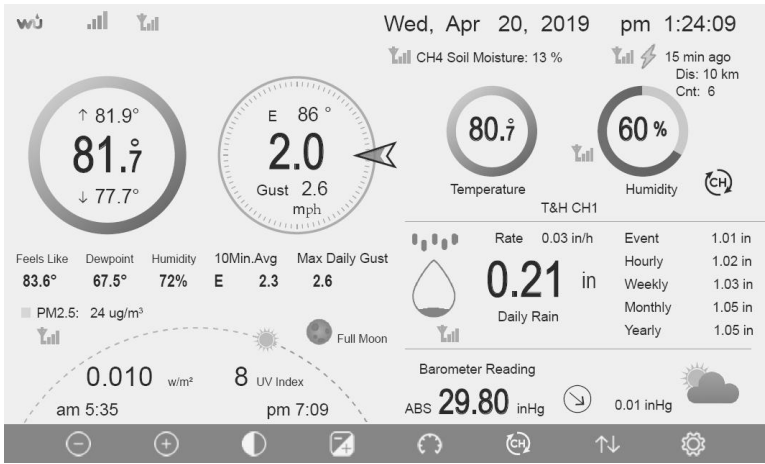

Light Background Display

Note: Sunrise/sunset time display will only work properly when GEO location has been set up correctly. GEO setup can be carried out under setup menu.

4.7.2 Key functions

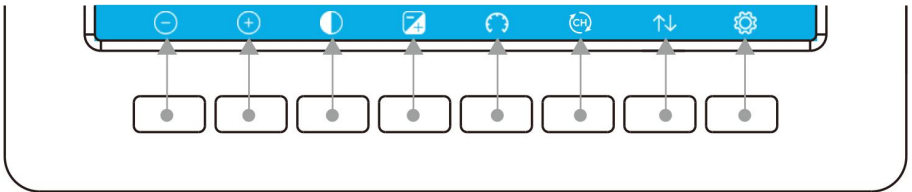

Figure 19: Buttons around the display

There is a set of eight keys on the bottom of the display console. The following tables briefly explains the function of these keys.





















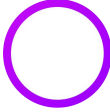

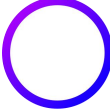
Icon	Description
	Brightness control key Press this key to decrease the brightness
	Brightness control key Press this key to enhance the brightness
	Backlight on/off key Press this key to on/off the backlight
	Background key Press this key to choose between dark background display and light background display
	Pressure display key Press this key to choose the display between Absolute pressure and Relative pressure.
	Channel key Press this key to Shift the display between indoor temp & humidity, Multiple Channel temp& humidity and scroll automatically mode
	History key Press this key once to view Max/Min record; Press twice to enter History mode; Press three times to enter Graph Mode.
	Setting key Press this key to enter Setting Mode

Table: Console buttons









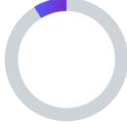

4.7.3 Main interface icons explain

4.7.3.1 Temperature Icon

Temperature Range (degF)	Color Ring	Temperature Range (degF)	Color Ring
< -10		50-60	
-10 to 0		60-70	
0 to 10		70-80	
10-20		80-90	
20-30		90-100	
30-40		100-110	
40-50		> 110	



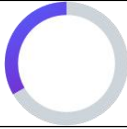
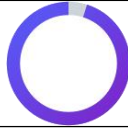





Note: please refer to the online manual for colorful display.

4.7.3.2 Humidity Icon

Humidity Range (%)	Color Ring	Humidity Range (%)	Color Ring
0%, No signal or dashes		50 to 60	
1 to 10		60 to 70	
10 to 20		70 to 80	
20 to 30		80 to 90	
30 to 40		90 to 99	
40 to 50		100%	

4.7.3.3 Current wind direction indication , 10-minute average wind direction indication .

4.7.3.4 Hourly Rainfall Icon

Hourly Rain (in)	Icon	Hourly Rain (in)	Color Ring
0.0		0.6 to 0.8	
0 to 0.2		0.8 to 1	
0.2 to 0.4		1 to 1.2	
0.4 to 0.6		1.2 to 1.4	

4.8 Multiple Channel Selection and Scroll Mode

Multi-channel sensor is an optional sensor, not included in the package. If you have multiple wireless sensors, while in normal mode, press the  key to toggle display in sequence of indoor, ch1, ch2...ch8, scroll display. Please note if only CH2 is received, it will skip CH1, and toggle only between indoor and already learned sensors.

While in Scroll display mode, the scroll icon  will be displayed next to the indoor humidity, and will scroll every 5 seconds.

Note: For multi channel sensor, the history data will be saved to a SD card(not included).

4.9 History Mode

4.9.1 View and Reset MAX/MIN

While in normal display, press the  key once to view and reset minimum and maximums.

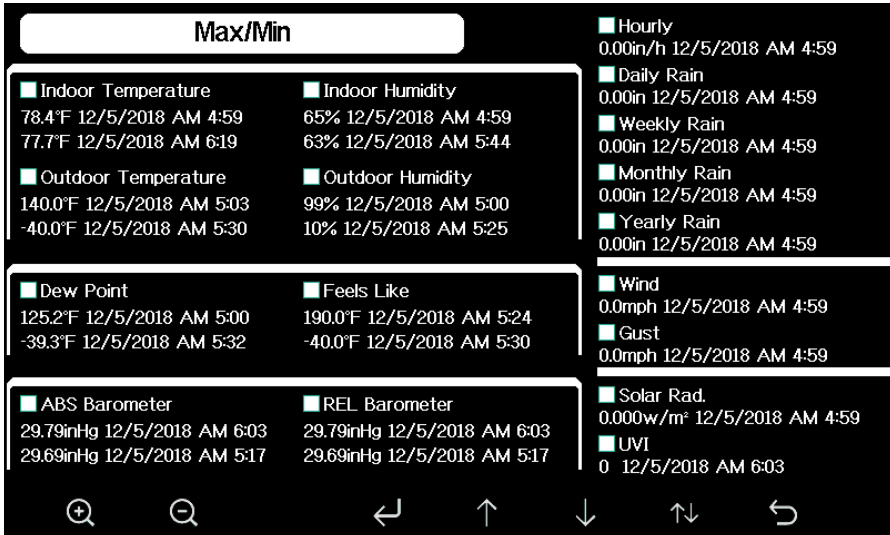













Figure 20: Max/Min Screen

Icon	Description
	Selection key Press this key to select the weather MAX/MIN record which need to clear
	Selection key Press this key to select the weather MAX/MIN record which need to clear
	Enter key While the desired weather MAX/MIN record selected , press this key to popup Message Box “Clear the Max/Min record?”. Press  key or  key to select YES or NO. Press the  key or









	key to confirm the selection.
	Up arrow key Press this key to change the activated option field
	Down arrow key Press this key to change the activated option field
	History key Press this key to select History data display.
	Return key Press this key to return to normal display mode



4.9.2 History Record Mode

While in normal display, press the  key twice to enter History Record Mode.

No	Time	Indoor Temperature (°F)	Indoor Humidity (%)	Outdoor Temperature (°F)	Outdoor Humidity (%)	Dew Point (°F)	Feels Like (°F)	Wind (mph)
2689	12/5/2018 AM 6:40	77.7	65	68.9	47	47.8	68.9	2.5
2690	12/5/2018 AM 6:45	77.7	65	68.9	47	47.8	68.9	2.5
2691	12/5/2018 AM 6:50	77.7	65	68.9	47	47.8	68.9	2.2
2692	12/5/2018 AM 2:40	77.9	65	68.9	47	47.8	68.9	2.5
2693	12/5/2018 AM 2:45	77.9	65	68.9	47	47.8	68.9	2.2
2694	12/5/2018 AM 2:50	77.9	65	68.9	47	47.8	68.9	2.2
2695	12/5/2018 AM 2:55	77.9	65	68.9	46	47.3	68.9	2.2
2696	12/5/2018 AM 3:00	77.9	65	68.9	46	47.3	68.9	2.2
2697	12/5/2018 AM 3:05	77.9	65	68.9	46	47.3	68.9	2.2
2698	12/5/2018 AM 3:10	77.9	65	68.9	46	47.3	68.9	2.2
2699	12/5/2018 AM 3:15	77.9	65	68.9	46	47.3	68.9	2.7
2700	12/5/2018 AM 3:20	77.9	64	68.9	46	47.3	68.9	2.5
2701	12/5/2018 AM 3:25	77.9	65	68.9	46	47.3	68.9	2.2
2702	12/5/2018 AM 3:30	78.1	65	68.9	46	47.3	68.9	2.2
2703	12/5/2018 AM 3:35	78.6	65	68.9	46	47.3	68.9	2.2
2704	12/5/2018 AM 3:40	78.6	65	68.9	46	47.3	68.9	2.2

Figure 21: History record Screen

Icon	Description
	File Select key Press this key to clear all history record
	Page Select key Press this key to enter particular page of the history data. Each page contains 16sets data.
	Scroll left key Press this key to view the left of the scrollable area.
	Scroll right key Press this key to view the right of the scrollable area.
	Page up key Press this key to scroll up the page you are viewing
	Page down key Press this key to scroll down the page you are viewing
	History key Press this key to select the Max/Min record or History.
	Return key Press this key to return to previous mode

While in History Record Mode, press  key to popup the Message Box: “Clear the history record?” Press “Yes” to clear all history records saved on console. Press  or  key to return to History record Mode.

No	Time	Indoor Temperature (°F)	Indoor Humidity (%)	Outdoor Temperature (°F)	Outdoor Humidity (%)	Dew Point (°F)	Feels Like (°F)	Wind (mph)
2721	12/5/2018 AM 5:13	78.4	65	24.8	54	10.4	24.8	0.0
2722	12/5/2018 AM 5:18	78.4	65	59.0	73	50.4	59.0	0.0
2723	12/5/2018 AM 5:23	78.4	65	87.8	89	84.2	111.7	0.0
2724	12/5/2018 AM 5:28				19	69.8	123.8	0.0
2725	12/5/2018 AM 5:33				39	-39.3	-22.0	0.0
2726	12/5/2018 AM 5:38				58	0.1	12.2	0.0
2727	12/5/2018 AM 5:43				74	33.4	41.0	0.0
2728	12/5/2018 AM 5:48				95	77.2	78.8	0.0
2729	12/5/2018 AM 5:52				24	67.6	113.0	0.0
2730	12/5/2018 AM 5:57				42	--	-36.4	0.0

⚠️ Clear the history record?

Figure 22: Clear History Record Screen









While in History Record Mode, press the key to enter the page selection mode:

No	Time	Indoor Temperature (°F)	Indoor Humidity (%)	Outdoor Temperature (°F)	Outdoor Humidity (%)	Dew Point (°F)	Feels Like (°F)	Wind (mph)
2721	12/5/2018 AM 5:13	78.4	65	24.8	54	10.4	24.8	0.0
2722	12/5/2018 AM 5:18	78.4	65	59.0	73	50.4	59.0	0.0
2723	12/5/2018 AM 5:23	78.4	65	87.8	89	84.2	111.7	0.0
2724	12/5/2018 AM 5:28	78.4	65	123.8	19	69.8	123.8	0.0
2725	12/5/2018 AM 5:33				39	-39.3	-22.0	0.0
2726	12/5/2018 AM 5:38				58	0.1	12.2	0.0
2727	12/5/2018 AM 5:43				74	33.4	41.0	0.0
2728	12/5/2018 AM 5:48				95	77.2	78.8	0.0
2729	12/5/2018 AM 5:52				24	67.6	113.0	0.0
2730	12/5/2018 AM 5:57				42	--	-36.4	0.0
2731	12/5/2018 AM 6:24	77.4	64	-4.0	71	-11.2	-4.0	0.0

View data on page 1 to 171

00171



Figure 23: view a specific page of history Screen

Press  or  to select a digit in a number, press  or  key to change the number. Press  or  to change the activated option field, toggle OK or Cancel then press  or  key to confirm.

4.9.3 Graph Mode

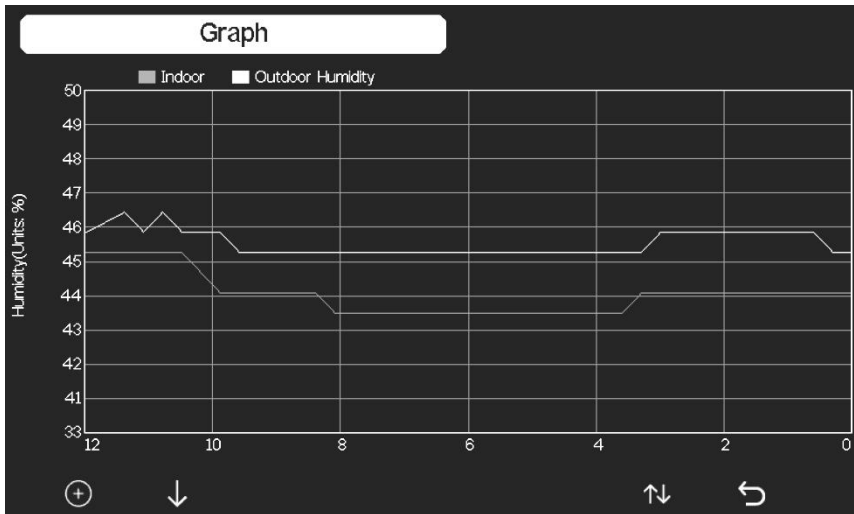
While in History Record Mode, press the  key once to enter Graph Mode.



Press  to shift the data display of 12/24/48/72H. Press  to view the graph of the following data:

- Indoor Outdoor humidity
- Dew Point and Feels like
- Indoor Outdoor temperature
- Wind speed and Gust
- Wind Direction

UVI

Solar Radiation

Rainfall hourly and daily

Barometer(REL & ABS)

4.9.4 Optional Sensor Display Mode



To view the full display of multi-channel sensors you can do this:

While in Graph Mode, press the  key once to enter Optional Sensor Display Mode.

CH1 27.1°C 67%	CH2 27.2°C 67%	CH3 27.3°C 66%	CH4 27.3°C 66%	CH5 27.1°C 67%	CH6 27.4°C 67%	CH7 27.3°C 66%	CH8 27.3°C 66%
Soil CH1 0%	Soil CH2 0%	Soil CH3 0%	Soil CH4 0%	Soil CH5 0%	Soil CH6 0%	Soil CH7 0%	Soil CH8 32%
PM12.5 CH2 29ug/m³ Moderate AQI 24H 87 68	PM12.5 CH3 31ug/m³ Moderate AQI 24H 91 93	Water CH2 Normal	Water CH4 Normal	Lightning 20 min ago Dis Cnt 20km 5			
							

Note: Channel names can be edited on this page.

4.10 Setting Mode

While in normal display, press the  key to enter Setting Mode. You can select the below sub-mode by pressing the  key

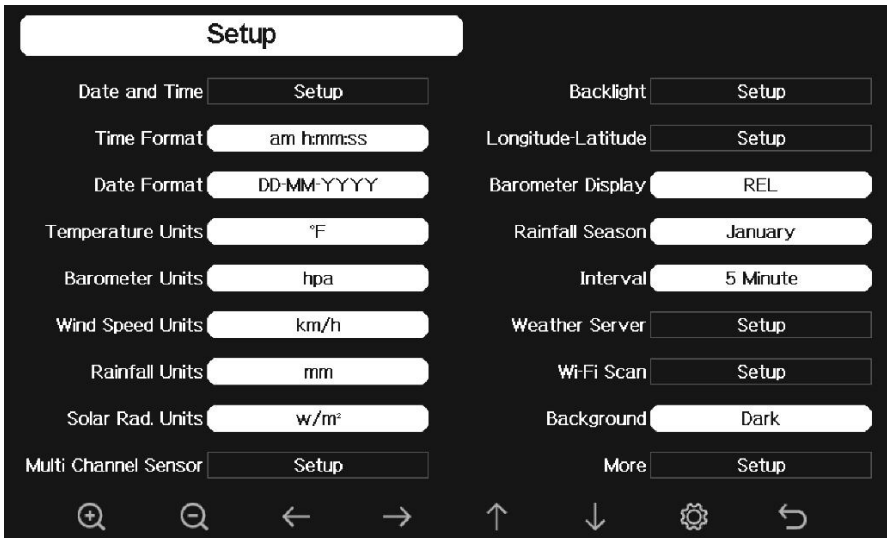











Figure 24: Setup Menu Screen

Icon	Description
	Select key Press this key to select the unit or scrolls the value
	Select key Press this key to select the unit or scrolls the value.
	Left key Press this key to select the set value.
	Right key Press this key to select the set value.
	Up arrow key Press this key to change the activated option field
	Down arrow key Press this key to change the activated option field
	Set key Press this key to select the Setting sub-Mode
	Return key Press this key to return to previous mode

4.10.1 Date and Time setting

While in Menu Setting Mode, press  key to select Date and Time

Setup field, press  or  key to enter Date and Time Setup mode:

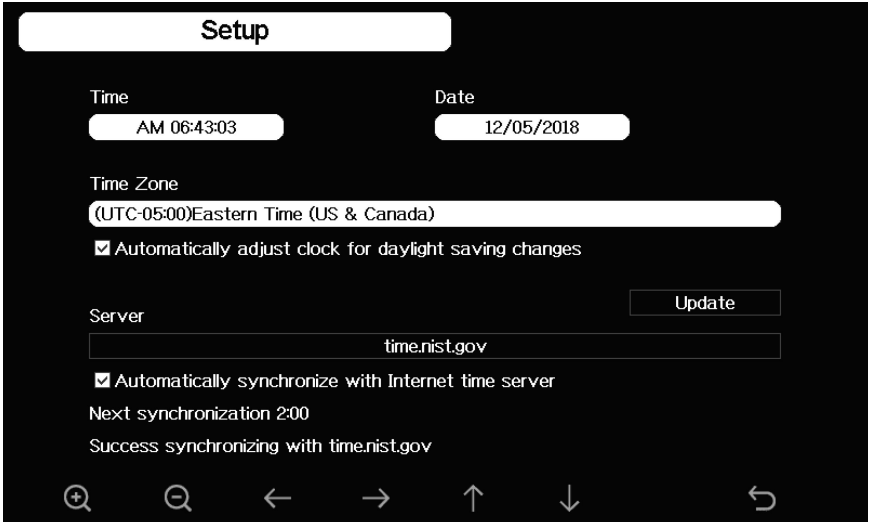







Figure 25: Time and date Setup Screen

1) Time setting (hour/minute/second)

Press  key to select time setting field, and the hour digit will turn red,









press the  or  key to change the hour setting. Press  to set

the minute, the minute digit will turn red, press the  or  key to







change the minute setting. Press  to set the second, and the second

digit will turn red, press the  or  key to change the second setting



2) Date setting

Press  key to select Date setting field, the day digit on focus turns red, press the  or  key to change the day setting. Press  to set the month, then month digit focused will turn red, press the  or  key to change the month setting. Press  to set the year, the year digit on focus will turn red, press the  or  key to change the year setting

3) Time zone setting

Press  key to select Time zone setting field, press the  or  key to change the time zone setting. Press  key to select Update field, press the  or  key to update the time immediately.

4) Automatically synchronize with internet time server

The time server is time.nist.gov. Press the  or  key to tick "Automatically synchronize with internet time server" and press "update" to synchronize with time server immediately. Console time will be updated at 2:01am automatically when internet access is possible.

4.10.2 Time Format setting

Press  to change the time format between hour: minute: second (h:mm:ss), hour: minute: second AM (h:mm:ss AM) and AM hour: minute: second (AM h:mm:ss).

4.10.3 Date Format setting

Press  to change the time format between DD-MM-YYYY, YYYY-MM-DD and MM-DD-YYYY

4.10.4 Temperature unit setting

Press  to change the temperature units of measure between °F and °C.

4.10.5 Barometric unit

Press  to change the temperature units of measure between inHg, mmHg and hpa

4.10.6 Wind speed unit

Press  to change the wind speed units of measure between mph, bft (Beaufort scale), ft/s, m/s, km/h and knot.

4.10.7 Rainfall unit

Press  to change the rainfall units of measure between in and mm

4.10.8 Solar Rad. Unit

Press  to change the solar radiation units of measure between W/m², lux and fc.

4.10.9 Multi Channel Sensor

In Multi channel sensor Setup Screen, you can rename the sensor or register the sensor again while the sensor lost connection to console display.

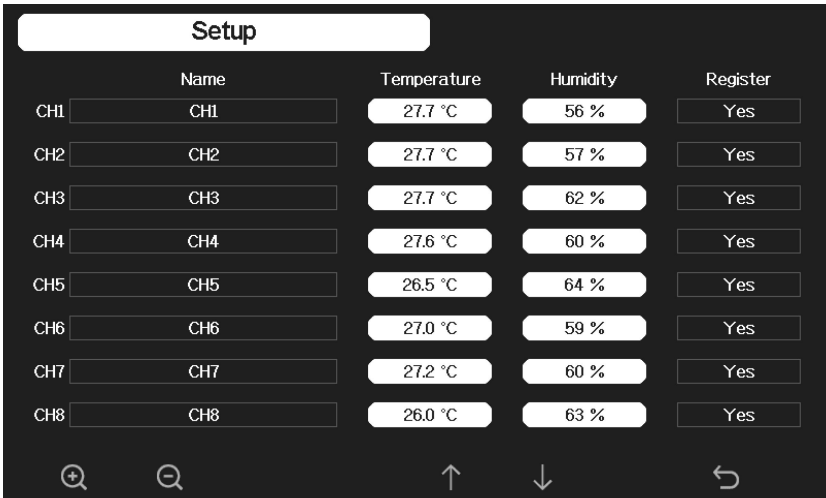











Figure 26: Multi channel sensor Setup Screen

Press  or  key to select Name setting field, the name on focus turns green, press the  or  key to pop up the keyboard to enter the sensor name. Press     to scroll to the character and press  to select the character. Press  to return to the setup page.

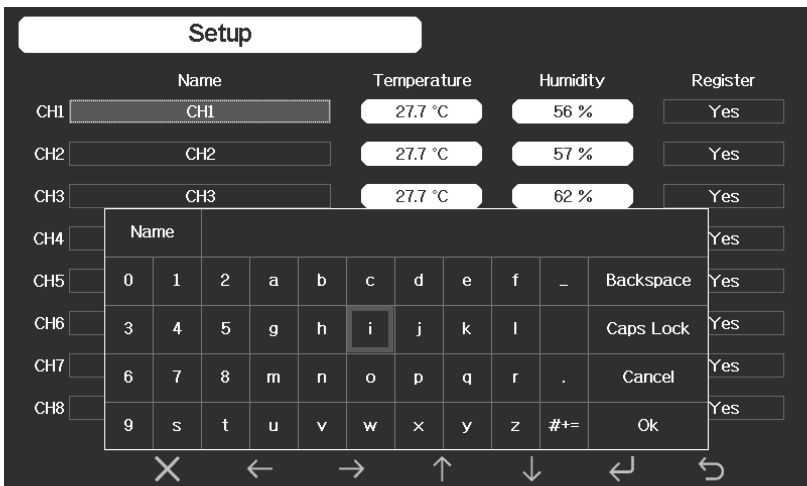



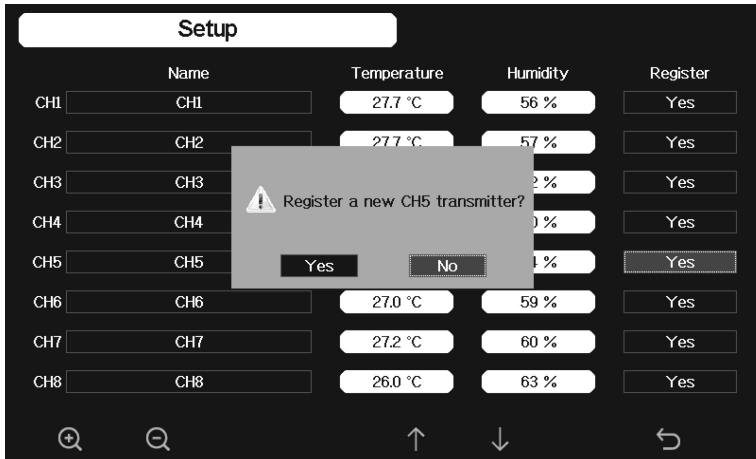





Figure 27: rename the sensor Screen

Press  or  key to select Register setting field, press the  or  key to register the selected sensor



4.10.10 Backlight setting

While in Menu Setting Mode, press  key to select Backlight Setup field, press  or  key to enter backlight Setup mode:

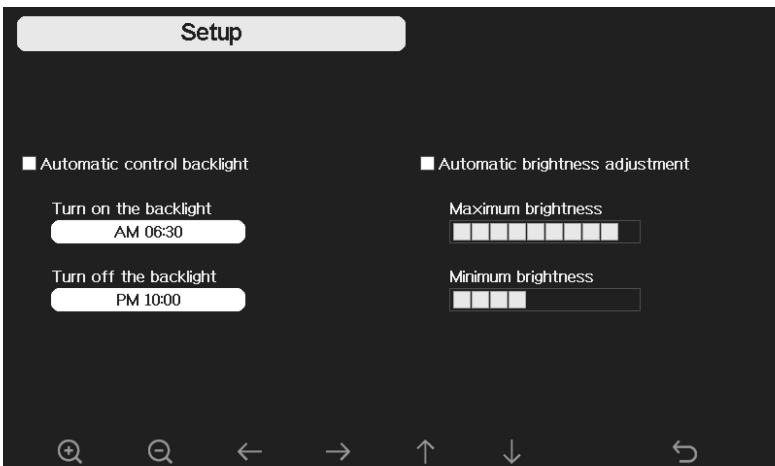

Figure 28: Backlight Setting Screen

Automatic control backlight: select this option, the backlight will auto turn on and off according the set time







Turn on the backlight: set the time of turning on backlight

Turn off the backlight: set the time of turning off backlight

Automatic brightness adjustment: select this option, the brightness will change according to the light intensity measured from outdoor sensor

Maximum brightness: set the maximum brightness while it is the highest light intensity



Minimum brightness: set the minimum brightness while it is the weakest light intensity

Icon	Description
	Select key Press this key to select the unit or scrolls the value
	Select key Press this key to select the unit or scrolls the value.
	Left key Press this key to select the set value.
	Right key Press this key to select the set value.
	Up arrow key Press this key to change the activated option field
	Down arrow key Press this key to change the activated option field
	Return key Press this key to return to previous mode

If the auto backlight turn-on time has been set, you can press  key to turn off the backlight within the turn on time. Backlight will turn on again automatically at next turn on time. You can press any key to turn on the backlight for 60s within the turn off time

4.10.11 Longitude: Latitude setting

While in Menu Setting Mode, press  key to select Longitude: Latitude

Setup field, press  or  key to enter Longitude Latitude Setup mode:

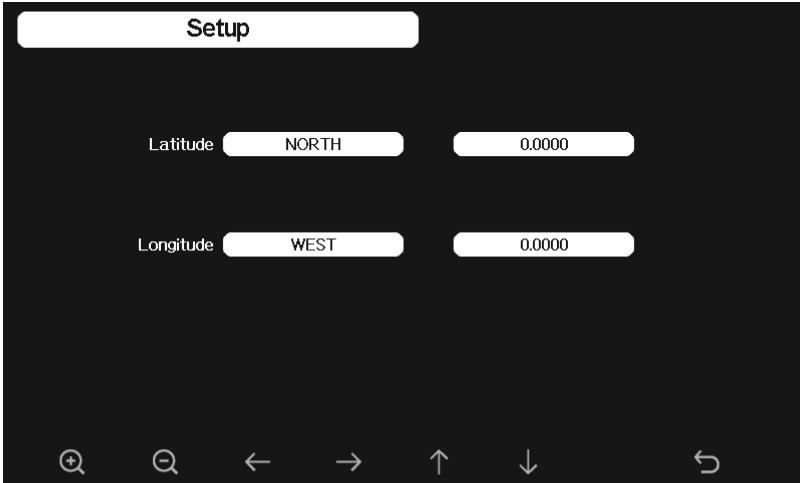



Figure 29: Longitude and Latitude Setting Screen

The sunrise/sunset times will be calculating automatically base on the Longitude and Latitude. Your location GEO info can be found on mobile compass page. Two digits after decimal should be enough for this feature to be working correctly.

4.10.12 Barometric display

Press  to change the barometer display between REL (relative pressure) and ABS (absolute pressure)

4.10.13 Rainfall season (default: January)

Press  to change the beginning of the rainfall yearly season month. The default is January. Rainfall season influence the annual rainfall

maximum, minimum and total value. When one month was selected, the annual rainfall and annual max/min rainfall were zero clearing at 0:00 of the first day of the selected month.

4.10.14 Storing Interval (1-240minutes Selectable)

4.10.15 Weather Server

You may jump to section 5.10.16 now to have your console connected with your Wi-Fi network first. Then back to section 5.10.15 to have cloud data hosting setup completed.

Your console is capable of sending your sensor data to select internet-based weather services. The supported services are shown in the table below:

Service	Description
Weather Underground	Site: https://wunderground.com provides local & long-range weather forecasts, weather reports, maps & tropical weather conditions for locations worldwide.
WOW	Site: https://wow.metoffice.gov.uk A UK based weather observation website.
Weather Cloud	Site: https://weathercloud.net A large network of weather stations reporting data in real time from all over the world.
Ecowitt Weather	Site: https://www.ecowitt.net Ecowitt's new weather server that can host a bunch of sensors that other services don't support at this time.

Table: Supported weather services

Note: If you are testing the setup with the outdoor sensor package nearby and indoor, you may want to consider connecting to Wi-Fi, but not yet configuring any of the weather services. The reason is that while indoor the temperatures and humidity recorded by the outdoor sensor, and as reported

to the weather service(s) will reflect indoor conditions, and not outdoor conditions. Therefore, they will be incorrect. Furthermore, the rainfall bucket may be tripped during handling, causing rain to register while it may not actually have been raining. One way to prevent this is to follow all instructions, except to use an incorrect password, on purpose! Then, after final outdoor installation, come back and change the password after clearing console history. That will start uploading to the services with a clean slate.























Press  or  key to enter Weather Server set up mode. The device can be configured to send real-time data to wunderground.com®. Enter the Station ID and Password obtained from Wunderground.com.



Figure 30: Weather Server setup screen

				
scroll value up	scroll value down	Scroll field up	Scroll field down	return to Setup



- 1) **Set Station ID.** Press  to highlight the Station ID. Enter your station ID. Press  to display the keyboard. Press     to scroll to the character and press  to select the character. Press the “OK” button to confirm. Press  to return to the setup page.
- 2)
- 3) **Set Station Key.** Press  to highlight the station key. Enter your password obtained from according weather server. Press  to display the keyboard. Press     to scroll to the character and press  to select the character. Press the “OK” button to confirm. Press  to return to the setup page.

4.10.15.1 Registering with and using wunderground.com

Perform the following steps to get the Station ID and Password on wunderground.com:

1. Visit Wunderground.com and select the Join link at the top of the page and sign up.

The screenshot shows the Wunderground.com website. At the top, there is a navigation bar with the logo and various menu items like 'Sensor Network', 'Maps & Radar', etc. Below the navigation bar, there is a 'Member Account' section. The main content area is titled 'Join Weather Underground' and contains a list of bullet points: 'Choose real-time alerts for your city.', 'Choose adding your webcam or personal weather station.', and 'You can delete your account at any time from your member settings.' Below this, there is a text prompt: 'The Weather Company needs your email to create your Weather Underground account.' The registration form includes an 'Email' field, a 'Password (5-30 characters)' field with a 'Show' link, and a 'Confirm New Password:' field. There is also a checkbox for 'I agree to the Terms of Use'. A blue button labeled 'Sign up for free' is highlighted with a red box. Below the button, there is a link: 'Already have an account? Sign in'.

2. Click My Profile and select My Devices to register your station

The screenshot shows the Wunderground.com website with the user profile page. The navigation bar at the top includes the logo and menu items. The 'My Profile' dropdown menu is open, showing options: 'Welcome back!', 'Member Settings', 'My Devices' (highlighted with a red box), and 'Sign Out'. The main content area displays weather information for San Francisco, CA. It shows a large temperature of 50°F, a 'Feels like 47°' indicator, and a forecast for the next 12 hours with temperatures ranging from 48° to 51°. A blue button labeled 'Full Forecast' is visible at the bottom of the main content area.

3. Select Add New Device.

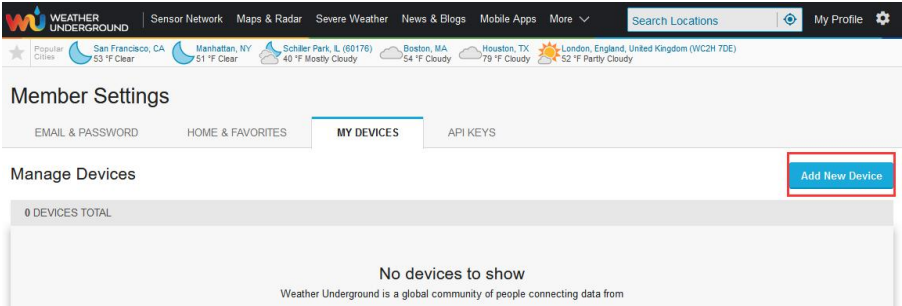

4. Find Personal Weather Station. Select 'other' and click 'Next'.

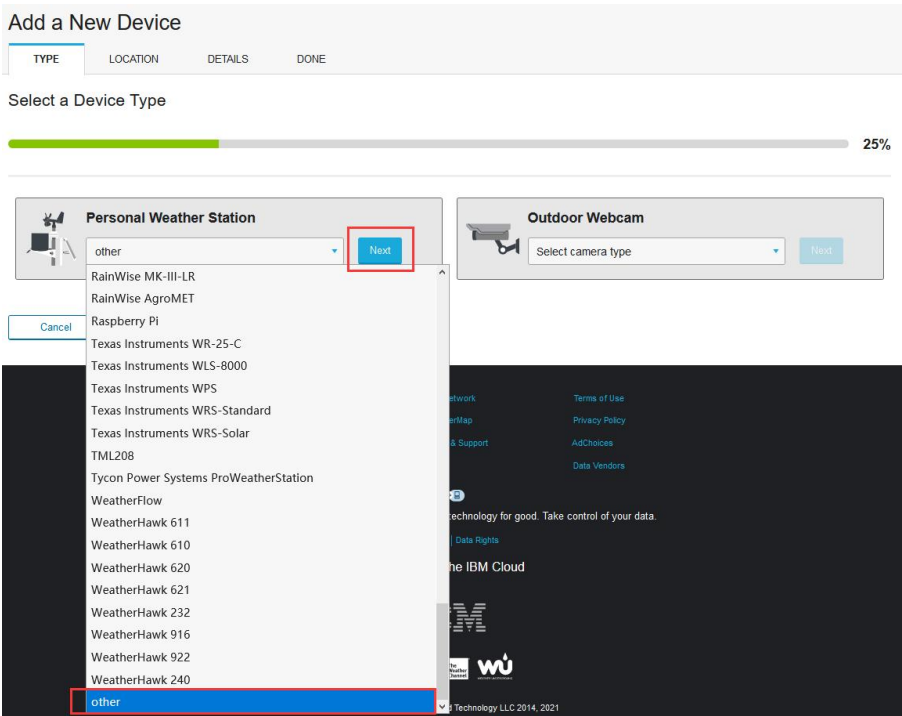

5. Select 'Address' or 'Manual' option, and find your local position. Press 'Next'.

Add a New PWS

TYPE LOCATION DETAILS DONE

Set Device Name & Location

50%

Device Location:

Address Manual

48.101.11.363

Your Location has been verified and added!

Elevation: 1841 ft.
Lat, Lon: 48.101, 11.363
Neighborhood: Krailling
Time Zone: Europe/Berlin

Back Next



6. This time you will be asked details about your weather station. Go ahead and fill out the form.

Add a New PWS

TYPE LOCATION DETAILS DONE

Tell Us More About Your Device

75%

Name:(Required)

Elevation:(Required)

Device Hardware:(Required)

Height Above Ground:

Surface Type:

Associate Webcam:

You Make Our Forecasts More Accurate, We Respect Your Privacy

Contribute to the Weather Underground community by sharing some information about yourself and your sensor. We use this information to manage your account and to improve the experience from the Weather Underground community. We may also share certain data for commercial purposes, such as your sensor location.

Learn more about how we take your privacy seriously

(Required)
 I Accept I Deny

Email Preferences:
 I would like to receive PWS notifications

Back Next



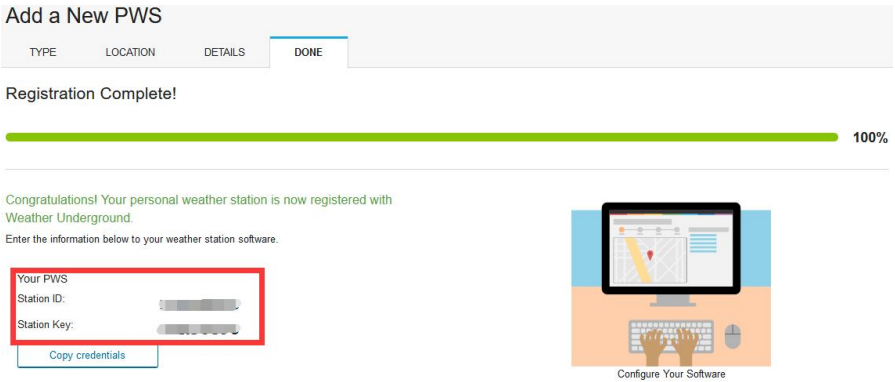

7. After completing the weather station, you will see station ID and key/password.

















8. Take note of the station ID and key/password and enter it in the Weather Server:



Figure 31: Weather Server setup screen

				
scroll value up	scroll value down	Scroll field up	Scroll field down	return to Setup



- 1) **Set Station ID.** Press  to highlight the Station ID. Enter your station ID. Press  to display the keyboard. Press     to scroll to the character and press  to select the character. Press the “OK” button to confirm. Press  to return to the setup page.
- 2)
- 3) **Set Station Key.** Press  to highlight the station key. Enter your password obtained from according weather server. Press  to display the keyboard. Press     to scroll to the

character and press  to select the character. Press the “OK”

button to confirm. Press  to return to the setup page.

9. Refresh the page, you may have to wait about a few minutes until the status becomes ‘Online’. Then you can click device name to view data.

Member Settings

EMAIL & PASSWORD HOME & FAVORITES **MY DEVICES** API KEYS

Manage Devices Add New Device

1 DEVICES TOTAL

Name	Location	Status	ID	Key	Type	Manage
HP2251.1	Shenzhen (Nanshan District), CN	● Online			PWS	Edit Delete Copy credentials ⋮

Items per page: 10 1 – 1 of 1 < >

4.10.15.2 Viewing data on wunderground.com

The most basic way to observe your weather station’s data is by using the wunderground.com web site. You will use a URL like this one, where your station ID replaces the text “STATIONID”:

<http://www.wunderground.com/personal-weather-station/dashboard?ID=STATIONID>

It will show a page such as this, where you can look at today’s data and historical data as well:

Darwin (+9:30 Zone) Test Station IDARWIN13 About this PWS Report Comments
 Forecast for Darwin, AU > -12.460 130.841 > 66 ft

PWS Data PWS Widgets WunderStation My PWS

PWS viewed 3 times since July 1, 2018

Satellite Webcam

Mapbox © OpenStreetMap | Improve this map

View WunderMap

Current Conditions station reported 0 second ago

78.4 °F

Feels Like 78.4 °F

12.1 mph Wind from **ENE**
 Gusts 12.5 mph

Dew Point: **66.2 °F** UVI: 0.0
 Humidity: **66%** Solar: 0 w/m²
 Precip Rate: **0.00 in/hr** Soil Moisture: --
 Precip Accum: **0.00 in** Soil Temp: --
 Pressure: **29.80 in** Leaf Wetness: --

7:08 AM 6:33 PM
 Waning Gibbous | 50% Illuminated

Weather History for Darwin, [IDARWIN13]

Previous Daily Mode July 6, 2018 View Next

Summary
July 6, 2018

	High	Low	Average		High	Low	Average
Temperature	82.4 °F	77.4 °F	79.9 °F	Wind Speed	13 mph	--	12 mph
Dew Point	73.8 °F	64.6 °F	70.1 °F	Wind Gust	14 mph	--	--
Humidity	79%	63%	70%	Wind Direction	--	--	West
Precipitation	0 in	--	--	Pressure	29.67 in	29.59 in	--

There are also some very useful mobile apps. The URLs provided here go to the Web version of the application pages. You can also find them directly from the iOS or Google Play stores:

- **WunderStation:** iPad application for viewing your station's data and graphs
- <https://itunes.apple.com/us/app/wunderstation-weather-from-your-neighborhood/id906099986>

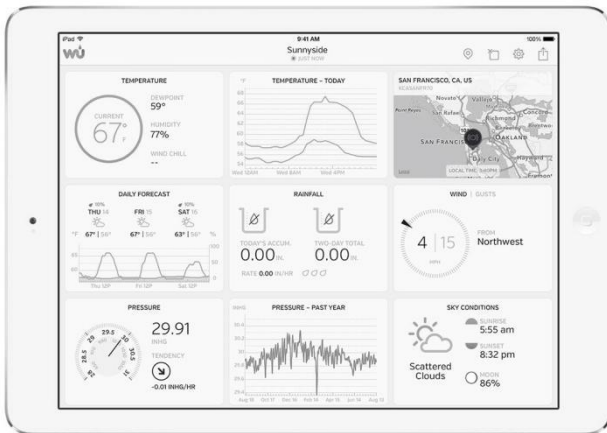

- **WU Storm:** iPad and iPhone application for viewing radar images, animated wind, cloud coverage and detailed forecast, and PWS station data
- <https://itunes.apple.com/us/app/wu-storm/id955957721>

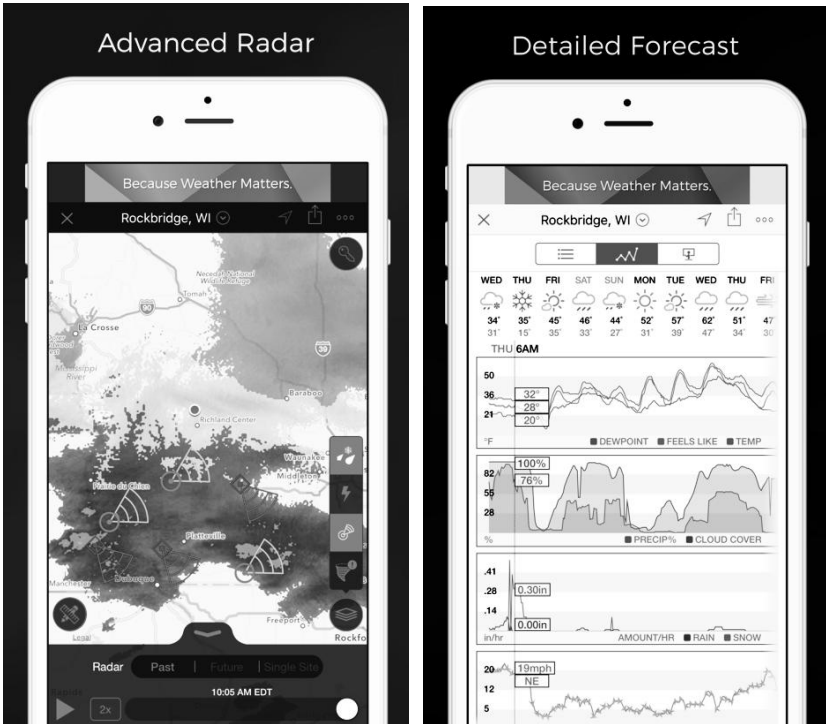

- **Weather Underground: Forecast:** iOS and Android application for forecasts
- <https://itunes.apple.com/us/app/weather-underground-forecast/id486154808>
- <https://play.google.com/store/apps/details?id=com.wunderground.android.weather&hl=en>



PWS Weather Station Monitor: View weather conditions in your neighborhood, or even right in your own backyard. Connects to wunderground.com

<https://itunes.apple.com/us/app/pws-weather-station-monitor/id713705929>

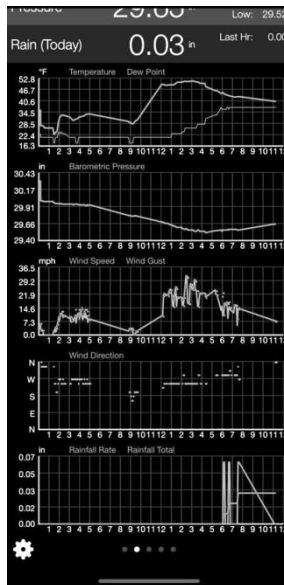

4.10.15.3 Registering with and using Ecowitt Weather

You can also use the Ecowitt Weather server to monitor and record all your sensors' data. Configure as follows:

- On the Weather Server page, set the reporting interval time(default: 1 minute).
- Visit the website: <https://www.ecowitt.net> on your computer and finish the registration on the page.
 - Press the upper left menu button and select Devices.
 - Press Add Device and input all the information needed(The MAC address can be found on the Weather Server page).
 - Press Save.
 - Press Dashboard on the menu. Your sensor data would be available on the dashboard within several minutes.

Note: When select device address on map, please wait until the map displays before selecting your address.

You may add a shortcut to the [ecowitt.net](https://www.ecowitt.net) website on the home page of your phone so that you can visit it just like opening an app.

4.10.15.4 Viewing data on [ecowitt.net](https://www.ecowitt.net)

You can observe your sensor's data by using the [ecowitt.net](https://www.ecowitt.net) web site. You will use a URL like this one, where your station ID replaces the text "STATIONID".

<https://www.ecowitt.net/home/index?id=STATIONID>

Note: If you want to share your station data with other users, you may use the Share option under the Menu to create a share link.

It will show a page such as this, where you can look at today's data and historical data as well.

Dashboard



Graph display



List display

6:37 PM Thu Aug 22 ecowitt.net 73%

Jaker GW1000
Reported 13 seconds ago 448347061

Daily Aug/22/2019

Time	Temperature (°C)	Humidity(%)	Dew Point(°C)	Feels Like(°C)	Temperature (°C)	Humidity(%)	Absolute(hPa)	Relative(hPa)	Wind Speed(m/s)	Wind Gust(m/s)	Wind Dir
2019-08-22 18:30	31.3	77	26.8	40.9	31.8	72	997.8	997.8	1.0	2.0	4
2019-08-22 18:25	31.5	77	26.9	41.3	31.8	71	997.7	997.7	1.1	1.5	2
2019-08-22 18:20	31.5	76	26.8	41.2	31.9	71	997.8	997.8	0.8	1.5	3
2019-08-22 18:15	31.6	76	26.9	41.4	32.0	71	997.7	997.7	0.9	2.0	2
2019-08-22 18:10	31.7	75	26.8	41.5	32.0	71	997.6	997.6	0.7	2.0	3
2019-08-22 18:05	31.8	75	26.8	41.6	32.0	71	997.6	997.6	0.8	2.6	2
2019-08-22 18:00	31.9	74	26.7	41.6	32.1	71	997.5	997.5	1.1	3.1	8
2019-08-22 17:55	31.9	75	26.9	41.9	32.0	70	997.5	997.5	1.1	3.6	7
2019-08-22 17:50	32.1	74	26.9	42.4	32.1	70	997.4	997.4	1.0	2.0	5
2019-08-22 17:45	32.2	74	27.0	42.6	32.1	70	997.4	997.4	1.7	2.6	1
2019-08-22 17:40	32.3	74	27.1	42.9	32.2	70	997.1	997.1	0.6	2.0	2
2019-08-22 17:35	32.5	73	27.0	43.1	32.2	69	997.3	997.3	0.9	2.6	6
2019-08-22 17:30	32.7	72	27.1	43.6	32.2	69	997.4	997.4	0.5	1.5	5

Weather Map

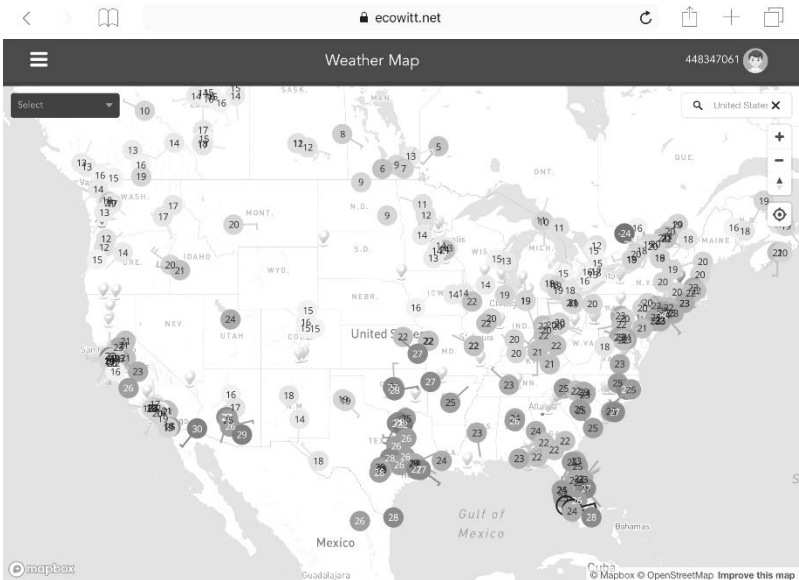

Email Alerts

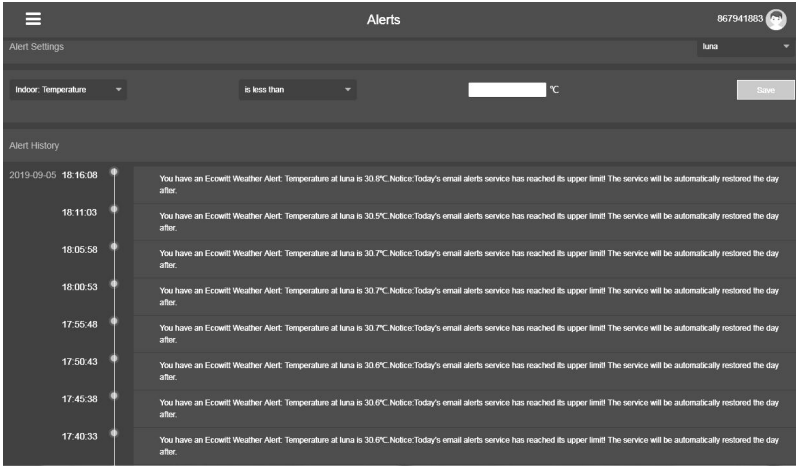

4.10.15.5 Customized server setup

For highly experienced users, it offers the option to send data to the user's own server. Press the "setup" button to enter Customized setup screen,



Figure 32 : Server setup screen

Select Enable button and select the protocol type. The website should has the same protocol with Wunderground or Ecowitt. Input all the information needed.

Customized

State	Enable
Protocol Type	Same As Wunderground
IP/Hostname	
Port	80
Interval	60 Second
Station ID	
Station Key	

Navigation icons: +, -, ←, →, ↑, ↓, ↶

Customized





State	Enable
Protocol Type	Same As Ecowitt
IP/Hostname	
Port	80
Interval	60 Second

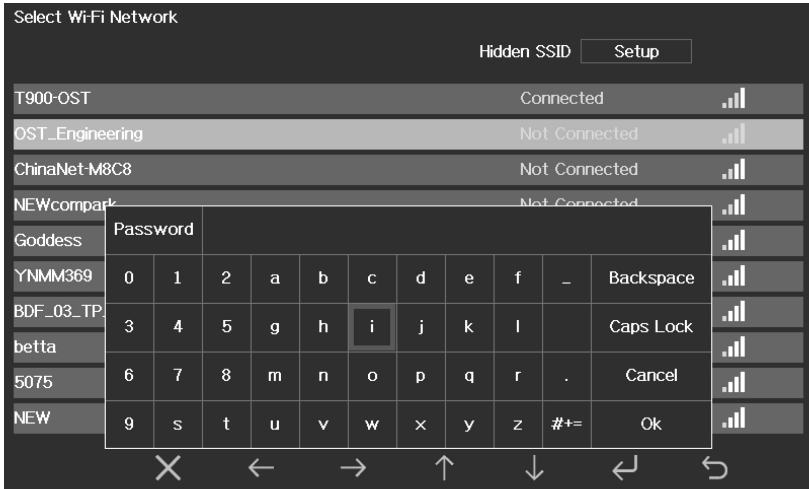

Navigation icons: +, -, ←, →, ↑, ↓, ↶



4.10.16 Connect Console to Your Router: Wi-Fi scan









Entering this mode, system will display all the available Wi-Fi networks. Select the SSID that you want console to be connected with (only supports 2.4GHz band Wi-Fi network), and enter passer word as required.











Press  or  key to select the Wi-Fi network. Press  key to confirm and enter the password. Press  key to return to normal display mode. It is possible that your network is not listed when Wi-Fi Scan is performed. Press  button and restart Wi-Fi Scan, this will usually solve the problem.

Only after connect to WLAN you can upload the data to weather website. If the Wi-Fi network connects successfully, the icon  will show on the left top of the console display. If the data upload to Wunderground.com successfully, the icon  will show on the left top of the console display. If the Wi-Fi network you would like to connect is with a hidden SSID, please follow below steps to connect:

1).Press   to select Hidden SSID setup, and press  key directly to enter.

2).Press  to highlight the SSID. Press  to display the keyboard and enter your SSID. Press     to scroll to the character and press  to enter the character. Press  to return to the setup page.

3).Press  to highlight the Password. Press  to display the keyboard and start to enter your password.. Press     to scroll to the character and press  to enter the character. Press  to return to the setup page.

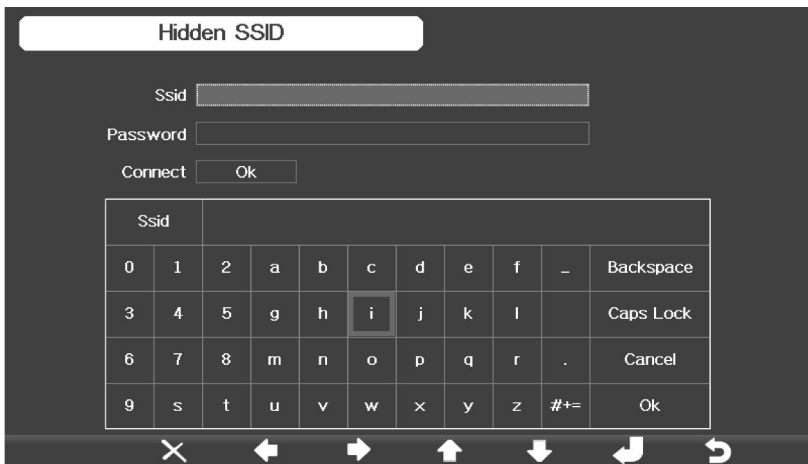

4).Press  to highlight the “OK” button beside “Connect ” to start connecting.

After connected successfully, the status will display” Connected”.

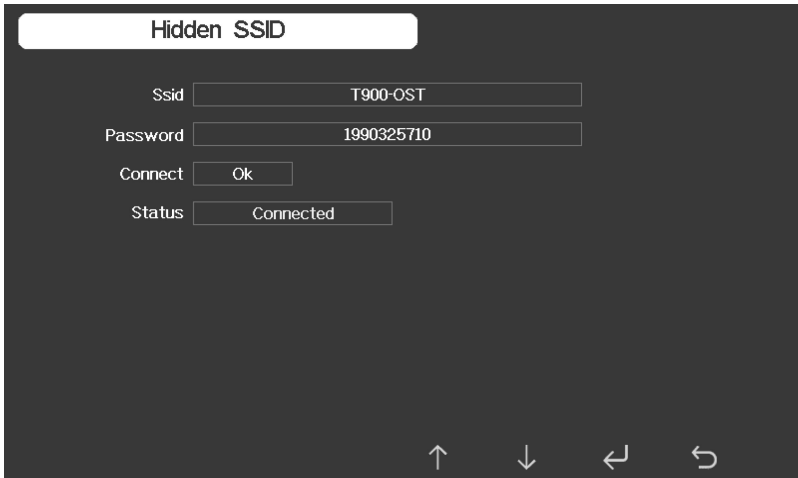









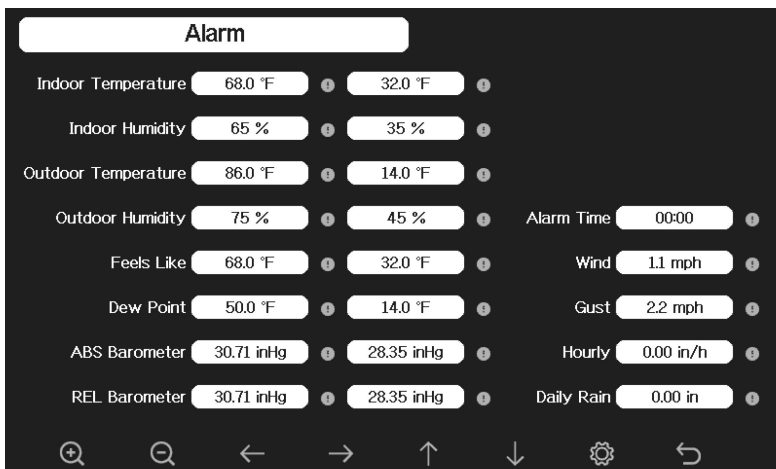

4.10.17 Background

While in Menu Setting Mode, press  key to select Background Setup field, press  or  key to choose between dark background display and light background display

4.11 Alarm Setting Mode









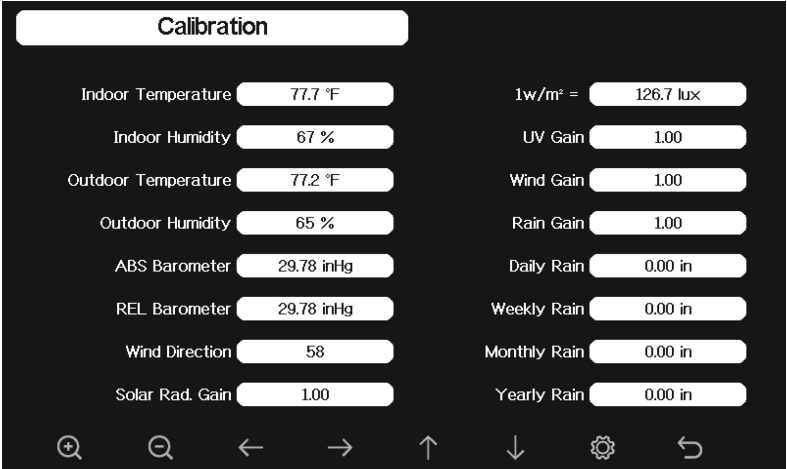

Icon	Description
	Select key Press this key to select the unit or scrolls the value
	Select key Press this key to select the unit or scrolls the value.
	Left key Press this key to select the set value.
	Right key Press this key to select the set value.
	Up arrow key Press this key to change the activated option field
	Down arrow key Press this key to change the activated option field
	Set key Press this key to select the Setting sub-Mode
	Return key Press this key to return to previous mode





The first row is high alarm value and the second row is low alarm value.

When weather alarm condition has been triggered, that particular alarm will sound for 120 second and the corresponding icon will flash until the weather condition doesn't meet the user set level. Press any key to mute the alarm.

4.12 Calibration Mode



Icon	Description
	Select key Press this key to select the unit or scrolls the value
	Select key Press this key to select the unit or scrolls the value.
	Left key Press this key to select the set value.
	Right key Press this key to select the set value.
	Up arrow key Press this key to change the activated option field
	Down arrow key Press this key to change the activated option field
	Set key Press this key to select the Setting sub-Mode
	Return key Press this key to return to previous mode

To adjust the parameter, press  to scroll to the parameter you wish to change. Press  to highlight the sign (positive vs. negative, if applicable) and significant digit. Press  or  to change the calibrated value.

Parameter	Type of Calibration	Default	Typical Calibration Source
Temperature	Offset	Current Value	Red Spirit or Mercury Thermometer (1)
Humidity	Offset	Current Value	Sling Psychrometer (2)
ABS Barometer	Offset	Current Value	Calibrated laboratory grade barometer
REL Barometer	Offset	Current Value	Local airport (3)
Wind Direction	Offset	Current Value	GPS, Compass (4)
Solar Radiation	Gain	1.00	Calibrated laboratory grade solar radiation sensor
1 w/m ²	Gain	126.7 lux	Solar radiation conversion from lux to w/m ² for wavelength correction (5)
Wind	Gain	1.00	Calibrated laboratory grade wind meter (6)
Rain	Gain	1.00	Sight glass rain gauge with an aperture of at least 4" (7)
Daily Rain	Offset	Current Value	Apply an offset if the weather station was not operating for the entire day.
Weekly Rain	Offset	Current Value	Apply an offset if the weather station was not operating for the entire week.
Monthly Rain	Offset	Current Value	Apply an offset if the weather station was not operating for the entire month.
Yearly Rain	Offset	Current Value	Apply an offset if the weather station was not operating for the entire year.

(1) Temperature errors can occur when a sensor is placed too close to a heat source (such as a building structure, the ground or trees).

(2)

- (3) To calibrate temperature, we recommend a mercury or red spirit (fluid) thermometer. Bi-metal (dial) and digital thermometers (from other weather stations) are not a good source and have their own margin of error. Using a local weather station in your area is also a poor source due to changes in location, timing (airport weather stations are only updated once per hour) and possible calibration errors (many official weather stations are not properly installed and calibrated).
- (4)
- (5) Place the sensor in a shaded, controlled environment next to the fluid thermometer, and allow the sensor to stabilize for 3 hours. Compare this temperature to the fluid thermometer and adjust the console to match the fluid thermometer.
- (6)
- (7) Humidity is a difficult parameter to measure electronically and drifts over time due to contamination. In addition, location has an adverse affect on humidity readings (installation over dirt vs. lawn for example).
- (8)
- (9) Official stations recalibrate or replace humidity sensors on a yearly basis. Due to manufacturing tolerances, the humidity is accurate to $\pm 5\%$. To improve this accuracy, the indoor and outdoor humidity can be calibrated using an accurate source, such as a sling psychrometer.
- (10)
- (11) The display console displays two different pressures: absolute (measured) and relative (corrected to sea-level).

To compare pressure conditions from one location to another, meteorologists correct pressure to sea-level conditions. Because the air pressure decreases as you rise in altitude, the sea-level corrected pressure (the pressure your location would be at if located at sea-level) is generally higher than your measured pressure.

Thus, your absolute pressure may read 28.62 inHg (969 mb) at an altitude of 1000 feet (305 m), but the relative pressure is 30.00 inHg (1016 mb).

The standard sea-level pressure is 29.92 in Hg (1013 mb). This is the average sea-level pressure around the world. Relative pressure measurements greater than 29.92 inHg (1013 mb) are considered high pressure and relative pressure measurements less than 29.92 inHg are considered low pressure.

To determine the relative pressure for your location, locate an official reporting station near you (the internet is the best source for real time barometer conditions, such as Weather.com or Wunderground.com), and set your weather station to match the official reporting station.

- (12) Only use this if you improperly installed the weather station sensor array, and did not point the direction reference to true north.
- (13)
- (14) The default conversion factor based on the wavelength for bright sunlight is 126.7 lux / w/m² . This variable can be adjusted by photovoltaic experts based on the light wavelength of interest, but for most weather station owners, is accurate for typical applications, such as calculating evapotranspiration and solar panel efficiency.
- (15)
- (16) Wind speed is the most sensitive to installation constraints. The rule of thumb for properly installing a wind speed sensor is 4 x the distance of the tallest obstruction. For example, if your house is 20' tall and you mount the sensor on a 5' pole:

$$\text{Distance} = 4 \times (20 - 5)' = 60' \text{ or } = 4 \times (6.10 - 1.52) = 18.32\text{m}.$$

Many installations are not perfect and installing the weather station on a roof can be difficult. Thus, you can calibrate for this error with a wind speed multiplier.

In addition to the installation challenges, wind cup bearings (moving parts) wear over time.

Without a calibrated source, wind speed can be difficult to measure. We recommend using a calibrated wind meter (not included) and a constant speed, high speed fan.

Note: If located in southern hemisphere, please follow the steps to calibrate the wind direction:

1. Install the outdoor sensor package with the West arrow on the sensor pointing due East.
2. Check the wind direction offset (Default: equals to the current wind direction)

If:

Current wind direction offset < 180 , then it should be calibrated to be: current wind direction + 180

If:

Current wind direction offset > 180 , then it should be calibrated to be: current wind direction - 180

For example, if the current wind direction is 288, then you'll need to set the wind direction offset to be: $288-180=108$.

If the current wind direction is 12, then you'll need to set the wind direction offset to be: $12+180=192$.

- (17) The rain collector is calibrated at the factory based on the funnel diameter. The bucket tips every 0.01" or 0.1m of rain (referred to as resolution). The accumulated rainfall can be compared to a sight glass rain gauge with an aperture of at least 4" or 0.1m.
- (18) Make sure you periodically clean the rain gauge funnel.

Note: The purpose of calibration is to fine tune or correct for any sensor error associated with the devices margin of error. Errors can occur due to electronic variation (example, the temperature sensor is a resistive thermal

device or RTD, the humidity sensor is a capacitance device), mechanical variation, or degradation (wearing of moving parts, contamination of sensors).

Calibration is only useful if you have a known calibrated source you can compare it against, and is optional. This section discusses practices, procedures and sources for sensor calibration to reduce manufacturing and degradation errors. Do not compare your readings obtained from sources such as the internet, radio, television or newspapers. The purpose of your weather station is to measure conditions of your surroundings, which vary significantly from location to location.

NOTE: UV Calibration MUST be performed every 2 to 3 months to improve results. Over time, UV Index may alter results based on bright and strong sunlight conditions. This is why diligent UV Calibration is recommended.

4.13 More

On the More page, you can set the Calibration for the optional multi-channel soil moisture/PM2.5/temp and humidity sensor. You can also view or manage all the sensors ID on the Sensors ID Setup page.

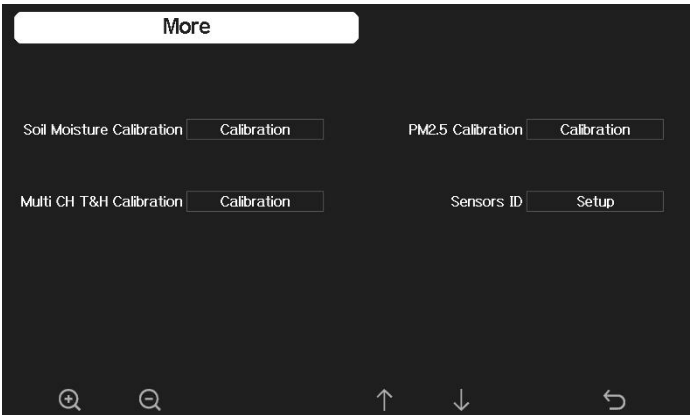

Calibration

Channel	Soil Moisture	Now AD	0%AD	100%AD	Customize	Reset
1	3%	83	70	500	OFF	Reset
2	62%	320	70	500	OFF	Reset
3	0%	26	70	500	OFF	Reset
4	51%	268	70	500	OFF	Reset
5	29%	188	70	500	OFF	Reset
6	0%	26	70	500	OFF	Reset
7	66%	335	70	500	OFF	Reset
8	63%	323	70	500	OFF	Reset

Calibration

Channel	PM2.5	PM2.5 Offset	Reset
1	34ug/m³	0	Reset
2	35ug/m³	0	Reset
3	42ug/m³	0	Reset
4	-	0	Reset

Calibration

Channel	Temperature	Humidity	Temp. Offset	Humi. Offset	Reset
1	--	--	0.0	0	Reset
2	82.2°F	45%	0.0	0	Reset
3	80.8°F	46%	0.0	0	Reset
4	81.0°F	47%	0.0	0	Reset
5	81.0°F	46%	0.0	0	Reset
6	81.3°F	47%	0.0	0	Reset
7	14.7°F	49%	0.0	0	Reset
8	81.3°F	45%	0.0	0	Reset

Note:

To calibrate the optional soil moisture sensor, please refer to the manual of the WH51 soil moisture sensor.

To calibrate the PM2.5 sensor, you'll need to find a reliable source, such as professional devices from your local air quality service.

To calibrate the temp and humidity sensor, please refer to section 4.9.19.

Sensor ID Setup

On this page you can set the following:

- View sensor ID, signal strength and battery power condition. 1-4 bars means 1-4 successful successive signal receptions without missed ones.
- Register the sensor when a new sensor is to be paired with.
- Stop unwanted sensor(like from your neighbor) to be received by disable that sensor type.
- Make console receiving data from a pre-defined sensor ID.

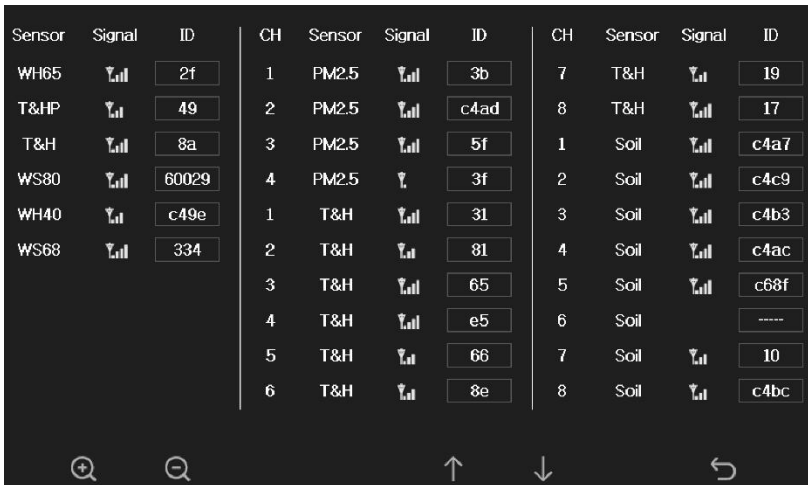

Sensor	Signal	ID	CH	Sensor	Signal	ID	CH	Sensor	Signal	ID
WH65	📶	2f	1	PM2.5	📶	3b	7	T&H	📶	19
T&HP	📶	49	2	PM2.5	📶	c4ad	8	T&H	📶	17
T&H	📶	8a	3	PM2.5	📶	5f	1	Soil	📶	c4a7
WS80	📶	60029	4	PM2.5	📶	3f	2	Soil	📶	c4c9
WH40	📶	c49e	1	T&H	📶	3l	3	Soil	📶	c4b3
WS68	📶	334	2	T&H	📶	8l	4	Soil	📶	c4ac
			3	T&H	📶	65	5	Soil	📶	c68f
			4	T&H	📶	e5	6	Soil	📶	----
			5	T&H	📶	66	7	Soil	📶	10
			6	T&H	📶	8e	8	Soil	📶	c4bc

Sensor	Signal	ID	CH	Sensor	Signal	ID	CH	Sensor	Signal	ID
WH65		2f	1	PM2.5		3b	7	T&H		19
T&HP		49	2	PM2.5		c4ad	8	T&H		17
T&H		8a	Please enter the correct hexadecimal ID. ID length needs to be less than 6.				Soil		c4a7	
WS80		60029					Soil		c4c9	
WH40		c49e	<input type="text" value="2f"/>				Soil		c4b3	
WS68		334					Soil		c4ac	
			<input type="button" value="Register"/> <input type="button" value="Disable"/>				Soil		c68f	
							<input type="button" value="Save"/> <input type="button" value="Cancel"/>			
5	T&H		66	7	Soil					
6	T&H		8e	8	Soil		c4bc			









Sensor	Signal	ID	CH	Sensor	Signal	ID	CH	Sensor	Signal	ID																																																								
WH65		2f	1	PM2.5		3b	7	T&H		19																																																								
T&HP		49	2	PM2.5		c4ad	8	T&H		17																																																								
T&H		8a	Please enter the correct hexadecimal ID. ID length needs to be less than 6.				Soil		c4a7																																																									
WS80		60029					Soil		c4c9																																																									
WH40	<table border="1"> <thead> <tr> <th>ID</th> <th colspan="10">2f</th> </tr> </thead> <tbody> <tr> <td>0</td> <td>1</td> <td>2</td> <td>a</td> <td>b</td> <td>c</td> <td>d</td> <td>e</td> <td>f</td> <td>_</td> <td>Backspace</td> </tr> <tr> <td>3</td> <td>4</td> <td>5</td> <td>g</td> <td>h</td> <td>i</td> <td>j</td> <td>k</td> <td>l</td> <td></td> <td>Caps Lock</td> </tr> <tr> <td>6</td> <td>7</td> <td>8</td> <td>m</td> <td>n</td> <td>o</td> <td>p</td> <td>q</td> <td>r</td> <td>.</td> <td>Cancel</td> </tr> <tr> <td>9</td> <td>s</td> <td>t</td> <td>u</td> <td>v</td> <td>w</td> <td>x</td> <td>y</td> <td>z</td> <td>#+=</td> <td>Ok</td> </tr> </tbody> </table>										ID	2f										0	1	2	a	b	c	d	e	f	_	Backspace	3	4	5	g	h	i	j	k	l		Caps Lock	6	7	8	m	n	o	p	q	r	.	Cancel	9	s	t	u	v	w	x	y	z	#+=	Ok	c4b3
ID											2f																																																							
0											1	2	a	b	c	d	e	f	_	Backspace																																														
3											4	5	g	h	i	j	k	l		Caps Lock																																														
6											7	8	m	n	o	p	q	r	.	Cancel																																														
9	s	t	u	v	w	x	y	z	#+=	Ok																																																								
WS68	<table border="1"> <thead> <tr> <th>ID</th> <th colspan="10">2f</th> </tr> </thead> <tbody> <tr> <td>0</td> <td>1</td> <td>2</td> <td>a</td> <td>b</td> <td>c</td> <td>d</td> <td>e</td> <td>f</td> <td>_</td> <td>Backspace</td> </tr> <tr> <td>3</td> <td>4</td> <td>5</td> <td>g</td> <td>h</td> <td>i</td> <td>j</td> <td>k</td> <td>l</td> <td></td> <td>Caps Lock</td> </tr> <tr> <td>6</td> <td>7</td> <td>8</td> <td>m</td> <td>n</td> <td>o</td> <td>p</td> <td>q</td> <td>r</td> <td>.</td> <td>Cancel</td> </tr> <tr> <td>9</td> <td>s</td> <td>t</td> <td>u</td> <td>v</td> <td>w</td> <td>x</td> <td>y</td> <td>z</td> <td>#+=</td> <td>Ok</td> </tr> </tbody> </table>										ID	2f										0	1	2	a	b	c	d	e	f	_	Backspace	3	4	5	g	h	i	j	k	l		Caps Lock	6	7	8	m	n	o	p	q	r	.	Cancel	9	s	t	u	v	w	x	y	z	#+=	Ok	c4ac
ID											2f																																																							
0											1	2	a	b	c	d	e	f	_	Backspace																																														
3											4	5	g	h	i	j	k	l		Caps Lock																																														
6											7	8	m	n	o	p	q	r	.	Cancel																																														
9	s	t	u	v	w	x	y	z	#+=	Ok																																																								
										c68f																																																								

																														10																																				
										c4bc																																																								

4.14 Factory reset



4.14.1 Re-register indoor transmitter





Press  or  key to select re-register indoor transmitter. Press  or  key to popup the Message Box "Register a new indoor transmitter?" Press  or  to select Yes or No. Press the  or  key to confirm the selection.

4.14.2 Re-register outdoor transmitter

Please reference section 5.13.1. Procedures and settings are similar to re-register indoor transmitter.









4.14.3 Automatic Clear Max/Min

To turn on/off automatically clear Max/Min record at 0:00hr every day.









Press  or  key to select Automatic clear Max/Min. Press  or  key to switch on/off.

When it is selected with ON option, min/max will be presented as daily min/max, and with OFF option selected, it is for history min/max record.









4.14.4 Reset to Factory

Press  or  key to select Reset to Factory. Press  or  key to popup the Message Box "Reset to factory default?" Press  or  to select Yes or No. Press the  or  key to confirm the selection.









4.14.5 Clear History

Press  or  key to select Clear History. Press  or  key to popup the Message Box "Clear the history record?" Press  or  to select Yes or No. Press the  or  key to confirm the selection.

4.14.6 Clear Max/Min

Press  or  key to select Clear Max/Min. Press  or  key to popup the Message Box "Clear the max/min record?" Press  or  to select Yes or No. Press the  or  key to confirm the selection.

4.14.7 Backup data

Press  or  key to select Backup data. Press  or  key to popup the Message Box "Copy history data to SD card?" Press  or  to select OK or Cancel. Press the  or  key to confirm the selection.

Note: You need to insert a SD card(not included) into the console before using this function.

4.14.8 About information

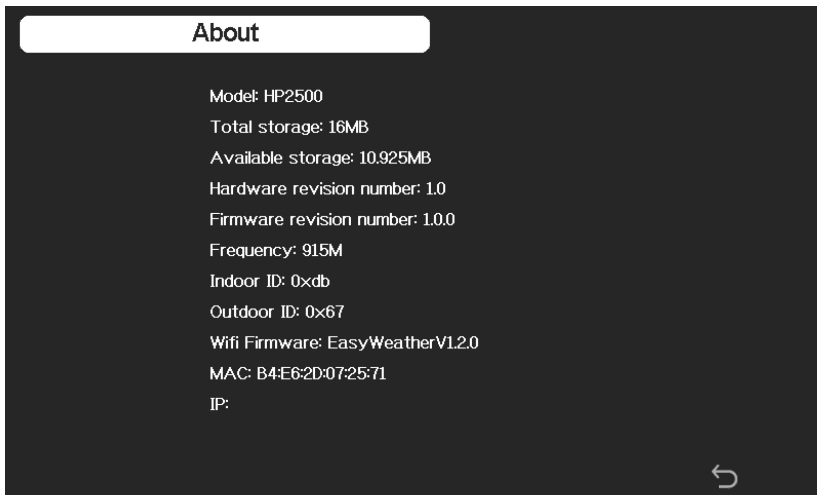

Note: This figure is just for reference(model and frequency will change according to different market). The actual display console may be with higher firmware version than this manual described because we will update the firmware occasionally.

5 Other Console Functions

5.1 Beaufort Wind Force Scale

If you have selected the use of Beaufort wind speed units, you can use the table below for reference. The Beaufort scale is based on qualitative wind conditions and how they would affect a ship's (frigate) sails (so yes, it is an "old" standard). It is therefore less precise than the other scales but is still in use in various locales.







Wind speed	Beaufort number	Description
0 - 1 mph, or 0 - 1.6 km/h	0	Calm
1 - 3 mph, or 1.6 - 4.8 km/h	1	Light air
3 - 7 mph, or 4.8 - 11.3 km/h	2	Light breeze
7 - 12 mph, or 11.3 - 19.3 km/h	3	Gentle breeze
12 - 18 mph, or 19.3 - 29.0 km/h	4	Moderate breeze
18 - 24 mph, or 29.0 - 38.6 km/h	5	Fresh breeze
24 - 31 mph, or 38.6 - 49.9 km/h	6	String breeze
31 - 38 mph, or 49.9 - 61.2 km/h	7	Near gale
38 - 46 mph, or 61.2 - 74.1 km/h	8	Gale
46 - 54 mph, or 74.1 - 86.9 km/h	9	Strong gale
55 - 63 mph, or 88.5 - 101.4 km/h	10	Storm
64 - 73 mph, or 103 - 117.5 km/h	11	Violent storm
74 mph and above, or 119.1 km/h and above	12	Hurricane

Table 1: Beaufort wind force scale

5.2 Weather Forecasting

The seven weather icons are Sunny, Partly Cloudy, Cloudy, Rainy, Stormy, Snowy and Storm Snowy.

The forecast icon is based on the rate of change of barometric pressure. Please allow at least one month for the weather station to learn the barometric pressure over time.

Sunny	Partly Cloudy	Cloudy
		
Pressure increases for a sustained period of time	Pressure increases slightly or initial power up	Pressure decreases slightly
Rainy	Stormy	Snowy
		
Pressure decreases for a sustained period of time	Pressure rapidly decreases	Pressure decreases for a sustained period of time, and temperature $\leq 0^{\circ}\text{C}$
Storm Snowy		
		
Pressure rapidly decreases, and temperature $\leq 0^{\circ}\text{C}$		

5.3 Lightning Alert

The lightning icon  will appear if the Dew Point exceeds 70 F. This means there is a chance of lightning storms forming.

5.4 Weather Forecasting Description and Limitations





In general, if the rate of change of pressure increases, the weather is generally improving (sunny to partly cloudy). If the rate of change of pressure decreases, the weather is generally degrading (cloudy, rainy or stormy). If the rate of change is relatively steady, it will read partly cloudy.



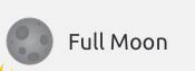



















The reason the current conditions do not match the forecast icon is because the forecast is a prediction 24-48 hours in advance. In most locations, this prediction is only 70% accurate and it is a good idea to consult the National Weather Service for more accurate weather forecasts. In some locations, this prediction may be less or more accurate. However, it is still an interesting educational tool for learning why the weather changes.

The National Weather Service (and other weather services such as Accuweather and The Weather Channel) have many tools at their disposal to predict weather conditions, including weather radar, weather models, and detailed mapping of ground conditions.

5.5 Moon Phase

In the event the moon phase is 100%, the icon  will appear in its place. In the event of 0%, the word “New Moon” will appear in its place.

Moon Phase	Image	Moon Phase	Image
Day 1		Day 14	
Day 2		Day 15	

Day 3		Day 16	
Day 4		Day 17	
Day 5		Day 18	
Day 6		Day 19	
Day 7		Day 20	
Day 8		Day 21	
Day 9		Day 22	
Day 10		Day 23	
Day 11		Day 24	
Day 12		Day 25	
Day 13 Full Moon		Day 26 New Moon	

6 Maintenance

The following steps should be taken for proper maintenance of your station

1. Clean the rain gauge once every 3 months. Rotate the funnel counter-clockwise and lift to expose the rain gauge mechanism, and clean with a damp cloth. Remove any dirt, debris and insects. If bug infestation is an issue, spray the array lightly with insecticide.

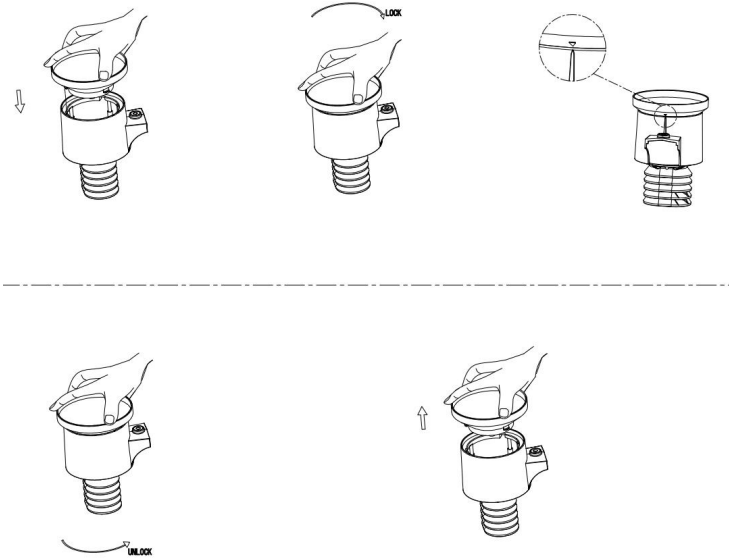

Figure 33: Rain gauge installation and maintenance



2. Clean the solar radiation sensor and solar panel every 3 months with a non-abrasive slightly damp cloth.
3. Replace batteries every 1-2 years. If left in too long, the batteries may leak due to environmental challenges. In harsh environments, inspect the batteries every 3 months (while cleaning the solar panel).
4. When replacing the batteries, apply a corrosion preventing compound on the battery terminals, available at Amazon and most hardware stores.
5. In snowy environments, spray the top of the weather station with anti-icing silicon spray to prevent snow build up.

7 Troubleshooting Guide

Look through the following table and locate an issue or problem you are experiencing in the left column and read possible solutions in the right column.

Problem	Solution
<p>Wireless remote (thermo-hygrometer) not reporting in to console.</p> <p>There are dashes on the display console.</p>	<p>The maximum line of sight communication range is about 300'. Move the sensor assembly closer to the display console.</p> <p>Resynchronize the remote sensor(s). Reference Section 5.13.2</p> <p>Install a fresh set of batteries in the remote sensor(s).</p> <p>Make sure the remote sensors are not transmitting through solid metal (acts as an RF shield), or earth barrier (down a hill).</p> <p>Radio Frequency (RF) Sensors cannot transmit through metal barriers (example, aluminum siding) or multiple, thick walls.</p> <p>Move the display console around electrical noise generating devices, such as computers, TVs and other wireless transmitters or receivers.</p>
<p>Outdoor sensor array does not communicate to the display console.</p>	<p>The sensor array may have initiated properly and the data is registered by the console as invalid, and the console must be reset. Press the reset button as described in Section Installation.</p> <p>With an open ended paperclip, press the reset button for 3 seconds to completely discharge the voltage.</p> <p>Take out the batteries and wait one minute, while covering the solar panel to drain the voltage.</p> <p>Put batteries back in and re-sync with console by powering down and up the console with the sensor array about 10 feet away.</p> <p>Bring the sensor array inside the house (you can disconnect it from the rest of the sensors). The LED next to the battery</p>

Problem	Solution
	<p>compartment will flash every 16 seconds. If the LED is not flashing every 16 seconds...</p> <p>Replace the batteries in the outside sensor array. If the batteries were recently replaced, check the polarity. If the sensor is flashing every 16 seconds, proceed to the next step.</p> <p>There may be a temporary loss of communication due to reception loss related to interference or other location factors,</p> <p>or the batteries may have been changed in the sensor array and the console has not been reset. The solution may be as simple as powering down and up the console.</p> <p>Replace the batteries in the outside sensor array.</p> <p>With the sensor array and console 10 feet away from each other, remove AC power from the display console and wait 10 seconds. Re-connect power.</p>
<p>Temperature sensor reads too high in the day time.</p>	<p>Make certain that the sensor array is not too close to heat generating sources or structures, such as buildings, pavement, walls or air conditioning units.</p> <p>Use the calibration feature to offset installation issues related to radiant heat sources. Reference 5.12.</p>
<p>Absolute pressure does not agree with official reporting station</p>	<p>You may be viewing the relative pressure, not the absolute pressure.</p> <p>Select the absolute pressure. Make sure you properly calibrate the sensor to an official local weather station. Reference Section 5.12 for details.</p>
<p>Rain gauge reports rain when it is not raining</p>	<p>An unstable mounting solution (sway in the mounting pole) may result in the tipping bucket incorrectly incrementing rainfall. Make sure you have a stable, level mounting solution.</p>
<p>Data not reporting to Wunderground.com</p>	<ol style="list-style-type: none"> 1. Confirm your password is correct. It is the password you registered on Wunderground.com. Your Wunderground.com password cannot begin with a non-alphanumeric character (a limitation of Wunderground.com, not the station). Example,

Problem	Solution
	<p>\$oewkrf is not a valid password, but oewkrf\$ is valid.</p> <ol style="list-style-type: none"> 2. 3. Confirm your station ID is correct. The station ID is all caps, and the most common issue is substituting an O for a 0 (or visa versa). Example, KAZPHOEN11, not KAZPH0EN11 4. 5. If there's a number "1" on the station key, try to input the lower case of letter "L" to replace it. 6. Make sure the date and time is correct on the console. If incorrect, you may be reporting old data, not real time data. 7. 8. Make sure your time zone is set properly. If incorrect, you may be reporting old data, not real time data. 9. 10. Check your router firewall settings. The console sends data via Port 80.
No WiFi connection	<ol style="list-style-type: none"> 1. Check for WiFi signal strength symbol on the display . If wireless connectivity is successful and reporting to Wunderground.com, the WiFi icon  will be displayed the home page. 2. 3. Make sure your modem WiFi settings are correct (network name, password and security settings).

8 Specifications

Note: Out of range values will be displayed using “---”:

Outdoor sensor	Specification
Transmission distance in open field	100 m (330 ft.)
RF Frequency	433/868/915MHz depending on location (North American:915MHz; Europe:868MHz; Other areas:433MHz)
Temperature range	-40°C – 60°C (-40°F - 140°F)
Temperature accuracy	± 1°C, or ± 2°F
Temperature resolution	0.1°C, or 0.1°F
Humidity range	10% ~ 99%
Humidity accuracy	± 5%
Humidity resolution	1%
Rain volume display range	0 – 9999 mm
Rain volume accuracy	± 10%
Rain volume resolution	0.3 mm (for volume < 1,000 mm) 1 mm (for volume ≥ 1,000 mm), or 0.01 in (for volume < 100 in) 1 mm (for volume ≥ 100 in)
Wind speed range	0 – 50 m/s (0 ~ 100 mph)
Wind speed accuracy	± 1 m/s (speed < 5 m/s) ± 10% (speed ≥ 5 m/s), or ± 0.1 mph (speed < 11 mph) ± 10% (speed ≥ 11 mph)
UV-Index range	0 - 15
Light range	0 – 200 kLux
Light accuracy	± 15%
Sensor reporting interval	16 seconds

Table: Outdoor sensor specification

Indoor sensor	Specification
Temperature range	-10°C – 60°C (14°F - 140°F)
Temperature resolution	0.1°C, or 0.1°F
Humidity range	10% ~ 99%
Humidity resolution	1%
Barometric pressure range	300 – 1,100 hPa (8.85 – 32.5 inHg)
Barometric pressure accuracy	± 3 hPa in 700 – 1,100 hPa range
Barometric pressure resolution	0.1 hPa (0.01 inHg)
Sensor reporting interval	60 seconds
Alarm Duration	120 seconds

Table: Indoor sensor specification

Power	Specification
Base station/console	5V DC Adapter (included)
Indoor sensor	2 x AA 1.5 Alkaline batteries (not included)
Outdoor sensor	Solar panel (built-in)
Outdoor sensor (backup)	2 x AA 1.5V LR6 Alkaline (not included), or 2 x AA 1.5V Lithium battery (not included)

Table: Power specification

The primary power source for the outdoor sensor is the solar panel. When available solar power (light over recent period) is insufficient, the batteries will be used. In outdoor climates that frequently have sustained temperatures below 0°C (or 32°F) the use of Lithium batteries is strongly suggested as these are performing better than Alkaline batteries under such circumstances.

9 Warranty Information

We disclaim any responsibility for any technical error or printing error, or the consequences thereof.

All trademarks and patents are recognized.

We provide a 1-year limited warranty on this product against manufacturing defects, or defects in materials and workmanship.

This limited warranty begins on the original date of purchase, is valid only on products purchased, and only to the original purchaser of this product. To receive warranty service, the purchaser must contact us for problem determination and service procedures.

This limited warranty covers only actual defects within the product itself and does not cover the cost of installation or removal from a fixed installation, normal set-up or adjustments, or claims based on misrepresentation by the seller, or performance variations resulting from installation-related circumstances.