

ecowitt®



Weather Outdoor Sensor

Model: WS85



<https://s.ecowitt.com/JJKFMJ>

Table of Contents

1. Introduction	1
2. Pair with the gateways/consoles	1
3. Part List	3
4. Features	3
5. Overview	4
6. Setup Guide	4
6.1 Preparations	4
6.2 Install batteries in the sensor package	5
7. Ultrasonic anemometer with piezoelectric assembly ...	6
7.1 Before you mount	6
7.2 Mounting	7
8. Specification	11
9. Attention	13
9.1 About daily rain deviation	13
9.2 How to calibrate WS85	14
9.3 Wind speed 0 calibration for WS85	17
10. Warranty	19
11. Care and Maintenance	21
12. Contact Us	23
12.1 After-sales Service	23
12.2 Stay in Touch	23

1.Introduction

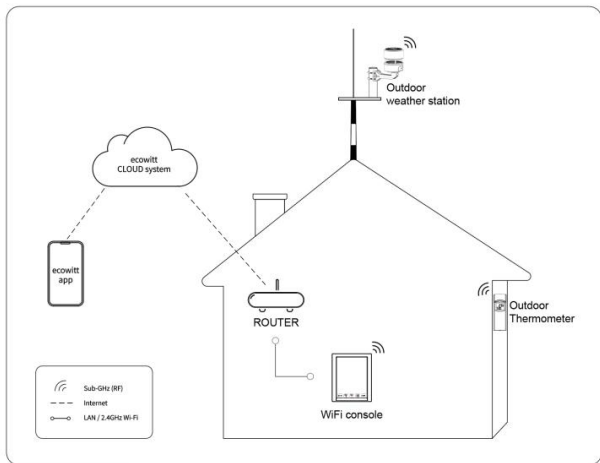

Figure 1 Ecowitt Ecosystem

2.Pair with the gateways/consales

Pair with the gateways: GW1100/GW2000/GW1200

		
GW1100	GW2000	GW1200

Table 1

Pair with the consoles:

HP2560/WS3800/WS3900/WS3910/HP2550/
WN1820/WN1821/WN1920/WN1980





HP2560	WS3800	WS3900/3910	HP2550	WN1820/1821	WN1920/1980
					
Show on the display	Show on the display	Show on the display	Show on the display	(just upload Ecowitt Cloud)	(Illumination , UV data just upload Cloud)

Table 2

Note: Just a weather sensor unit, it needs to be paired with other gateways or consoles to use.

The WN1920/WN1980 can't show the data of the illumination and UV on the display, just upload their data to the Ecowitt cloud.

The WN1820/WN1821 can't show the data of the WS85 on the display, just upload their data to the Ecowitt cloud.

3.Part List

1 x WS85	1 x User Manual
1 x Base Bracket	4 x $\phi 4.8*32$ Screws
1 x Simple Wrench	1 x M3*24 Screw
1 x L-shaped Wrench	1 x M3*12 Screw
4 x Screw Sleeves	2 x U-bolts

Table 3

Note:

2*AA Batteries for the sensor package are not included.

4.Features

- Piezoelectric rain gauge.
- Ultrasonic anemometer(start wind speed 0.5m/s).
- Solar Panel.
- Waterproof IPX5.

5.Overview



Figure 2: Sensor package assembly components

6.Setup Guide

6.1 Preparations

1. Open the package.
2. Preparing the receivers (gateways and consoles) to pair with the WS85.

6.2 Install batteries in the sensor package

Insert 2*AA batteries into the battery compartment after opening the battery compartment with a screwdriver, when the LED on the back of the sensor package lights up for 3 seconds and then blinks every 8.5 seconds. It assures that the sensor is transmitting data.

If the light does not come on for 3S, you can press the "Reset" button to start over. Make sure it blinks every 8.5 seconds.

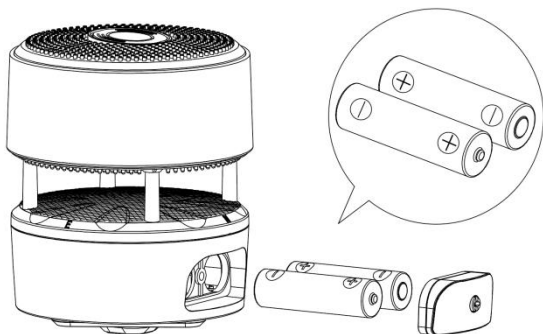

Figure 3: Battery installation diagram

Note:

Please make sure the battery is inserted correctly for its polarity as the system needs its initial power from this backup battery to start up the system before the solar panel charges up the accumulator and supply system power afterward.

When in high altitude areas, during wintertime, the sunshine time is short, and the system needs to be powered from this backup battery, we recommend Lithium batteries to be used for cold weather climates. Alkaline batteries can be used also, avoid rechargeable battery type of NiMh or NiCd.

7.Ultrasonic anemometer with piezoelectric assembly

7.1 Before you mount

Before mounting the weather sensor in a permanent location, you should test the sensor wireless connection in a temporary location, and make sure that the sensor has a good station to show the data on the gateway or console. At the same time, you can adroitly use the various functions and familiarize yourself with the performance of the device.

Note:

1. The WS85 should be installed in an open area with no obvious obstructions around it.
2. To achieve best wind accuracy, make sure that the mounting pole itself is not blocking or disturbing the wind:

Incorrect installation

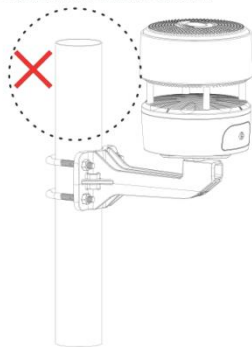

Properly installation



Figure 4 The wrong example of installation of the WS85

7.2 Mounting

1. You can attach a pole (not included) to a permanent structure and then attach the sensor package to it (see Figure 4).

The U-bolts accommodate on pole with diameter of 1.0 -1.5 inch (pole not included).

2 ways to install the WS85:

Bracket horizontal mounting way:



Bracket vertical mounting way:

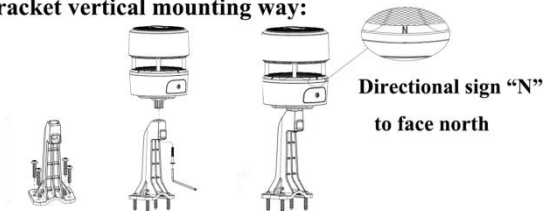

Figure 5: Sensor package mounting diagram

Make sure the mounting pole is vertical. Use a level as needed.

Now you will need to align the whole package in the proper direction by rotating it on top of the mounting pipe as needed.

If you are unsure about the direction:

Locate the arrow labeled "NORTH" that you will find on top of the connector tube of the sensor package. You must rotate the whole sensor package until this arrow points due "NORTH" (synchronize the direction

on the phone after open compass APP), and screw the bottom threaded cover to the direction of the “NORTH H”, As the picture shows:

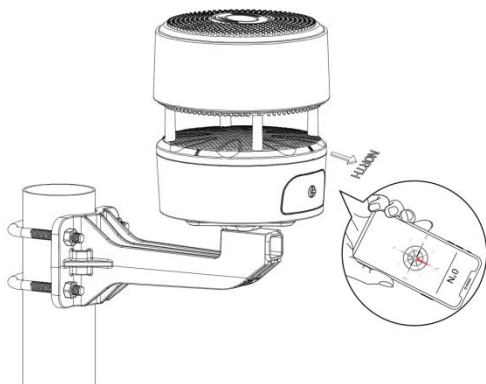

Figure 6

To achieve proper alignment, it is helpful to use a compass (many cell phones have a compass application).

Note:

In Southern hemisphere, it is not necessary to change the orientation to “SOUTH” as its solar panel is a rounded type and it is orientation free for its charging capability.

Ensure that the mounting tube for the sensor package is installed upright to maintain proper vertical alignment. You can adjust the mounting pipe to achieve this. Next, also make sure the mounting of the anemometer body on the pipe is level. If it is not, wind direction and speed readings may not operate correctly or accurately. Adjust the mounting assembly as necessary.

Make sure you check, and correct, if necessary, the north orientation again. Now tighten the bolts. Do not over tighten, but make sure strong wind or rain cannot move the sensor package.

8.Specification

Model	WS85
Dimensions	93*93*126mm
Dimensions With Bracket	160*93*161mm
Weight	350g
Material of Plastic Casing	ASA+PC、PC
Rainfall Metering range	0mm to 9999mm
Rainfall Metering accuracy	<5mm/h ($\pm 20\%$) 5mm/h~50mm/h($\pm 10\%$) >5 0mm/h($\pm 20\%$)
Rainfall Metering resolution	0.1mm
Wind speed Metering range	0m/s to 40m/s
Wind speed Metering accuracy	<10m/s, ± 1 m/s; ≥ 10 m/s, $\pm 10\%$
Wind speed Metering resolution	0.1m/s (starting speed > 0.5m/s)
Wind direction Metering range	0° to 359°
Wind direction Metering accuracy	$\pm 15^\circ$
Wind direction Metering resolution	1°

Data reporting Interval	8.5s
RF Connection Frequency	920/915/868/433MHz (depending on local regulations)
RF Wireless Range (in open areas)	Over 150 meters (500 ft.)
Operating Temperature Range	-40°C to 60°C (-40°F to 140°F)
Protection Rating	IPX5
Built-in Solar panel	7.5V±5%/30mA±10%
Power Supply	2*AA batteries (not included)
Battery Life	1 Year

Table 4

Note:

- The wind speed is detected by every 2s.
- The wind speed reading will be a real-time value (The latest sampling data will be reporting to the receiver).
- The wind gust reading will be the max wind speed in the past 48s.
- When the wind speed is lower than 5m/s, the dispersion of wind direction will increase.
- The primary power source for the sensor is the solar

panel. When available solar power (light over recent period) is insufficient, the batteries will be used.

9.Attention

9.1 About daily rain deviation



Figure 7: Daily rain deviation for WH40 and WS85

The daily rain deviation of WS85 is very small in the long run, but under certain conditions the deviation can be larger: as the rain drop size and wind speed can have different impacts on the sensor output which lead to this variance.

The WS85 product suffers from this imperfectness. If you are very demanding on rain data accuracy, we suggest you buy WH40 and use it together with WS85. If there is no precise requirement on data of each rain, then WS85 is just fine: After all the device works well after a longer run time.

9.2 How to calibrate WS85

Ensure your mobile phone and gateway are in the same router, the WS85 has been paired with the gateway.

1. Set the Calibrate in the Ecowitt app

If you have data from a relatively accurate weather station. You can use the data to do the calibration.

2. Make sure your mobile device is connected to the same Wi-Fi network.

3. Click "... " on top right corner and choose "Calibration".

4. For a certain parameter (Use "Wind Gain" as an illustration in Figure 8). Calculate the offset or gain based on data from reference and ecowitt sensor.

5. Fill in the offset/gain from step 4 and click Save.

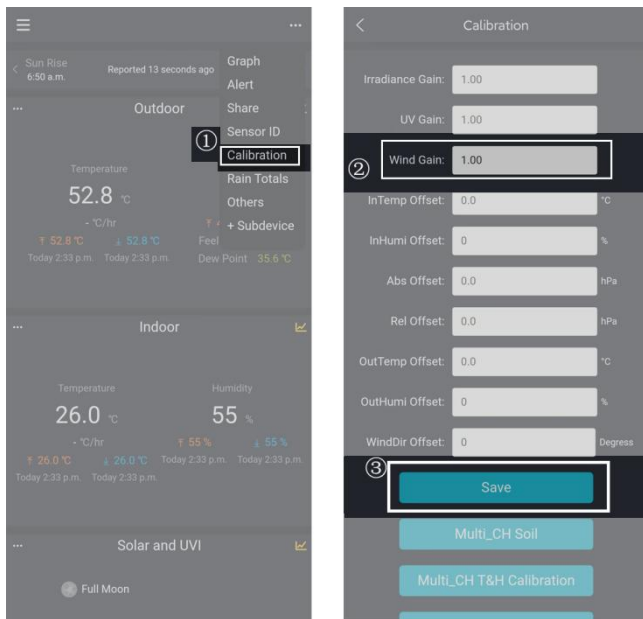

Figure 8

The WS85 is equipped with a haptic rain sensor, and the system offered a way that users can calibrate the rain sensor accuracy by themselves.

To carry out a proper calibration, please check the following:

1. A reference will be needed to record the rainfall value, and it is quite important to have the ability to record the rain rate. For this, our WH40 rain sensor can be used for this purpose.
2. There are five rain gain parameters you can set: Piezo Rain1: Rain5. So, we leave Rain1 as it is unless you can confirm it made constantly same result, and then you can adjust this.
3. Have rain data recorded, like this: we set rain4 gain to $6/7.5 = 0.8$. For easier handling, you can set rain2:rain3:rain5 all the 0.8 for the time being. Only when different rain rates are recorded, you have the WS85 rain divided by 0.8 to get 1.0 rain, and then have the (reference/WS85/0.8) calculated again and fill up the corresponding rain gain setting precisely.

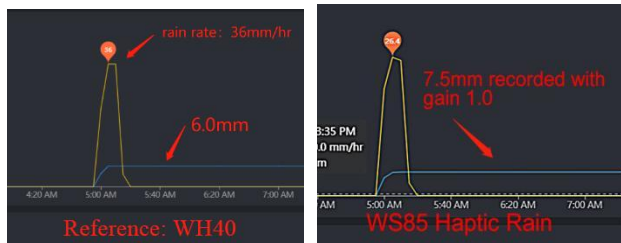

Figure 9: Rainfall values recorded for WH40 and WS85



Figure 10: Set five rain gain parameters

9.3 Wind speed 0 calibration for WS85.

1. In a windless room, find a soft cloth to cover the top cover and the wind speed area of the WS85, after holding the CAL button for 3 seconds, the light will be bright for 5 seconds and then start to flash, after waiting the light has closed, and the wind speed will be reset to zero.

As the picture shows:

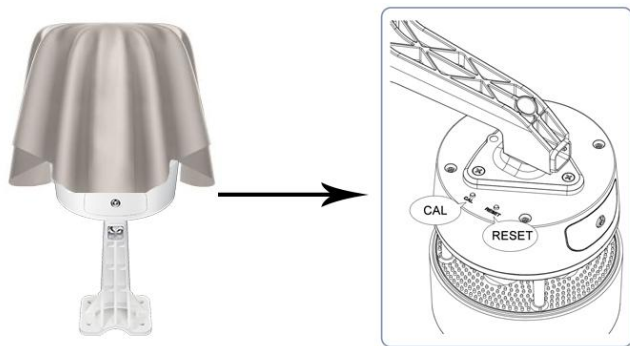

Figure 11

2. In the normal state, press the CAL button three times to turn the LED off: stop the light flash. After the LED has been closed, if want to restart the light function: Press the reset button to restart it.

10. Warranty

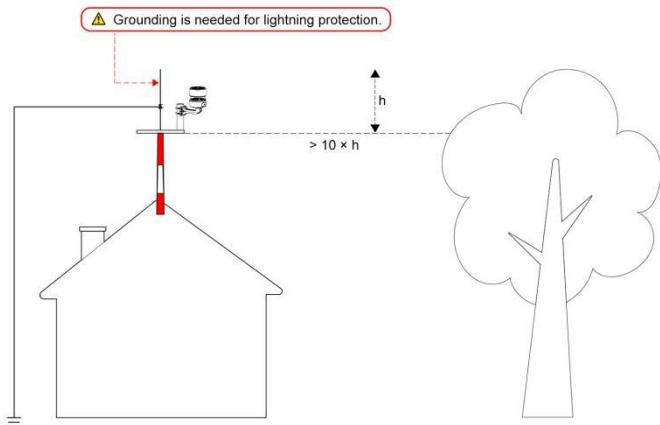

Figure 12

Note: Sensor damage, due to lack of grounding protection against lightning ESD discharge, is not covered by warranty.

We disclaim any responsibility for any technical error or printing error or the consequences thereof.

All trademarks and patents are recognized.

We provide a 1-year limited warranty on this product against manufacturing defects or defects in materials and workmanship.

This limited warranty begins on the original date of purchase, is valid only on products purchased, and only to the original purchaser of this product. To receive warranty service, the purchaser must contact us for problem determination and service procedures.

This limited warranty covers only actual defects within the product itself and does not cover the cost of installation or removal from a fixed installation, normal set-up or adjustments, or claims based on misrepresentation by the seller, or performance variations resulting from installation-related circumstances.

Manufacture: Shenzhen Fine Offset Electronics Co., Ltd.

Address: 4/F, Block C, JiuJiu Industrial City, Shajing Town, Baoan District, Shenzhen City, China

11. Care and Maintenance

When batteries of different brands or types are used together, or new and old batteries are used together, some batteries may be over-discharged due to a difference in voltage or capacity. This can result in venting, leakage, and rupture and may cause personal injury.

- Do not mix Alkaline, Lithium, standard, or rechargeable batteries.
- Always purchase the correct size and grade of battery most suitable for the intended use.
- Always replace the whole set of batteries at one time, taking care not to mix old and new ones, or batteries of different types.
- Clean the battery contacts and also those of the device prior to battery installation.
- Ensure the batteries are installed correctly about polarity (+ and -).
- Remove batteries from products during periods of non-use. Battery leakage can cause corrosion and damage to this product.
- Remove used batteries promptly.
- For recycling and disposal of batteries, and to protect the environment, please check the internet or your local phone directory for local recycling centers and/or follow

local government regulations

The provided solar panel charges a super capacitor on this WS85. In normal conditions (solar light intensity over 20klux and lasted longer than 2 hours), the super capacitor peak voltage displayed on the battery tile from your dashboard should be above 3.5v and lower than 5.5v. If it does not exceed 2.5v, please check the top part of your WS85, and make sure it is free from dust coverage. Use a brush to clean up the surface for higher solar charging efficiency.

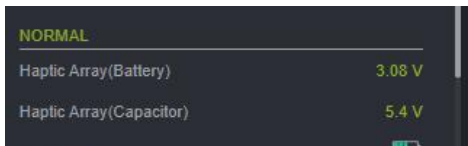

Figure 13

12. Contact Us

12.1 After-sales Service

Order Issues:

If you encounter any missing or incorrect shipments of Ecowitt products purchased, please reach out to the respective platform's customer service from the store where you bought the product for assistance.

Usage Inquiries:

Our product is continuously changing and improving, particularly online services and associated applications. To download the latest manual, and additional help, and for any issues related to product usage feel free to contact our customer support team at support@ecowitt.com. We are committed to aiding and resolving any concerns you may have.

12.2 Stay in Touch

Ask questions, watch setup videos, and provide feedback on our social media outlets. Follow Ecowitt on Discord, YouTube, Facebook and Twitter.

